

Deadbolts



We take the worry out of
protecting what's valuable to you.
Lockwood: *no worries*[®]

LOCKWOOD

ASSA ABLOY

25YEAR MECHANICAL
WARRANTY

www.lockweb.com.au

Contents



Paradigm®
005 Double
Cylinder Deadbolt
page 3



Paradigm®
005 Latching
page 7



Paradigm®
Pull Handle Lockset
Deadbolt
page 10



Paradigm®
Pull Handle Lockset
Deadlatch
page 12



Paradigm®
Pull Handle Lockset
Dummy Handle
page 14



Symmetry®
Deadbolt Single Cylinder
page 17



Symmetry®
Double Cylinder
page 19

Paradigm® 005 Double Cylinder Deadbolt



The Paradigm® 005 Double Cylinder Deadbolt is the premium security solution with its innovative safety features. The contemporary styling can be combined with any lever or entrance handle to create an elegant security solution, ideal for residential and architectural applications.

Key Features

- Three function modes with DualSelect® provides combination of convenience and security
- High security cut resistant stainless steel bolt
- Safety Release™ automatically unlocks internal knob upon key entry from outside
- LockAlert® indicator shows lock status at a glance
- Available in round or square rose

Restricted Special Keying

Lockwood locks can be keyed to a number of controlled and/or specially keyed systems. These range from legally protected keys to protect against unauthorised duplication, which can also include specially designed key systems such as master key systems, which allow for different levels of mechanical access control.

Please refer to Lockwood Keying Catalogue or contact your local sales office or customer service for specific information.

Retrofitable

Replace your existing Deadbolt. Fits 54mm hole. 60-70mm adjustable backset. 32-48mm door thickness.

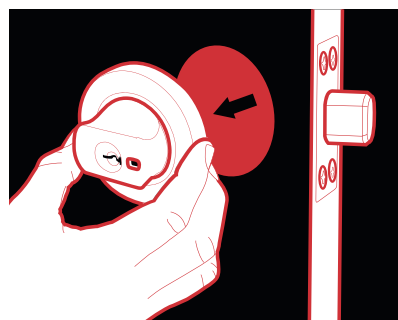

Product Details

Backset	60 to 70mm adjustable stainless steel bolt
Bolt	High security, cut resistant stainless steel bolt
Cylinder	5 pin tumbler mechanism. Brass cylinder and brass barrel
Door Thickness	32–48mm 32–36mm doors require a spacer (Included)
Finishes	Chrome Plate (CP) Satin Chrome Pearl (SP) Satin Chrome Brushed (SC) Everbrass (EVB) Satin Stainless Steel (SSS)*
Keying	Supplied individually keyed with two keys per lock, 78,000 key combinations, Key blank KB401B5P
Materials	High purity zinc alloy. Stainless steel version features 304 grade satin stainless steel rose, turn knob and trim
Strike	Box strike with concealed crossgrain door frame strengthening screw

*Satin Stainless Steel version only available in round rose.

Standards and Compliance

S18	(Security) Australian Lock Standard (AS4145.2 - 2008)
D8	(Durability) Australian Lock Standard (AS4145.2 - 2008)
C6	(Corrosion) Australian Lock Standard AS4145.2 - 2008)
K5	(Key Security) Australian Lock Standard AS4145.2 - 2008)

Paradigm® 005 Double Cylinder Deadbolt

Round Rose



Exterior



Interior

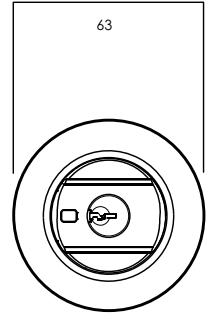
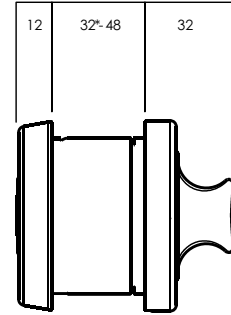
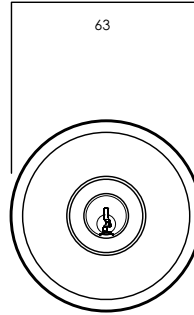

*32–36mm door thickness requires spacer ring (included)



Kinetic Defence®
Bump and pick resistant.



Counterbalance Bolt
Proportionally distributes the load between the door and door frame.



DualSelect®
Turn the key for safety mode. Turn the key further to select secure mode.



2 Keys Included
Can be keyed alike to other Lockwood door locks.



SafetyRelease™
Minimises the risk of being locked in.



Retrofitable
Replace your existing Deadbolt. Fits 54mm hole. 60-70mm adjustable backset. 32-48mm door thickness.



Anti-Corrosion
Successfully tested in accordance with AS2332.3.1:2001 neutral salt spray test.



LockAlert®
Interior Indicator shows lock status at a glance.



Safety Mode
Securely locked from outside and free from inside.



Secure Mode
Securely locked from both inside and outside. For when nobody is home.



Passage Mode
Free to enter from outside and free to exit from inside.

Paradigm® 005 Double Cylinder Deadbolt

Square Rose



Exterior



Interior

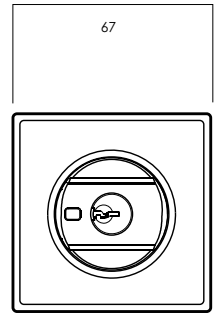
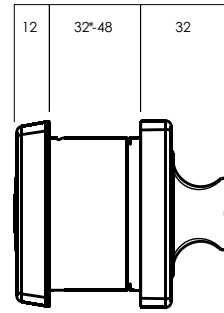
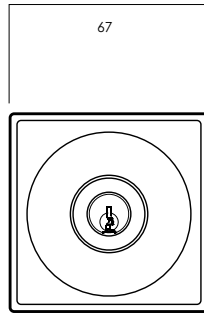

*32-36mm door thickness requires spacer ring (included)



Kinetic Defence®
Bump and pick resistant.



Counterbalance Bolt
Proportionally distributes the load between the door and door frame.



DualSelect®
Turn the key for safety mode. Turn the key further to select secure mode.



2 Keys Included
Can be keyed alike to other Lockwood door locks.



SafetyRelease™
Minimises the risk of being locked in.



Retrofitable
Replace your existing Deadbolt. Fits 54mm hole. 60-70mm adjustable backset. 32-48mm door thickness.



Anti-Corrosion
Successfully tested in accordance with AS2332.3.1:2001 neutral salt spray test.



LockAlert®
Interior Indicator shows lock status at a glance.



Safety Mode
Securely locked from outside and free from inside.



Secure Mode
Securely locked from both inside and outside. For when nobody is home.



Passage Mode
Free to enter from outside and free to exit from inside.

Ordering Procedure–Lever Sets

Sample part number 005/B1CPDP is made up of several sections. Choose your product by selecting an option from each section.

Paradigm® 005 Double Cylinder Deadbolt

Series	Type	Rose Style	Finish	Packaging	Keying
005	B	1	CP	DP	

Series	Rose Style	Packaging
Paradigm® 005	Round 1 Square 2	Universal Pack DP Trade Pack

Type	Finish	Keying Options
Bolt B	Satin Chrome Pearl SP Satin Chrome Brushed LSC Chrome Plate CP Everbrass EVB* Satin Stainless Steel SSS*	Special Keying-Residential Keyed Alike 5P 5KA Keyed Alike 6P 6KA Project Keyed 5P 5PK Project Keyed 6P 6PK Restricted Profile 5P 5RP

* Only available in Round Rose.

* For keying options please contact customer service.

Latching Paradigm® 005



The Lockwood Latching Paradigm® 005 is the premium security solution with its innovative safety features. It has a holdback function which keeps the latch in the retracted position when required. The contemporary styling can be combined with any lever or entrance handle to create an elegant security solution, ideal for residential and architectural applications.

Key Features

- Holdback function keeps the latch in the retracted position when required
- High security cut resistant Stainless Steel latch
- Concealed screw fixings for a neat and clean appearance
- Safety Release™ function minimises the risk of being deadlatched inside

Restricted Special Keying

Lockwood locks can be keyed to a number of controlled and/or specially keyed systems. These range from legally protected keys to protect against unauthorised duplication, which can also include specially designed key systems such as master key systems, which allow for different levels of mechanical access control.

Please refer to Lockwood Keying Catalogue or contact your local sales office or customer service for specific information.

Retrofitable

Replace your existing Deadlatch. Fits 54mm hole. 60mm backset. 32-48mm door thickness.

Product Details

Backset	60 mm stainless steel deadlatch
Latch	High security, cut resistant stainless steel latch
Cylinder	5 pin tumbler mechanism Brass cylinder and brass barrel
Door Thickness	32-48mm 32-36mm doors require a spacer (Included)
Finishes	Chrome Plate (CP) Satin Chrome Brushed (SC)
Keying	Supplied individually keyed with two keys per lock, 78,000 key combinations, Key blank KB401B5P
Materials	High purity zinc alloy
Strike	Box strike with concealed crossgrain door frame strengthening screw

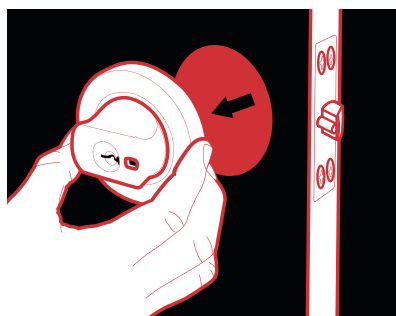

Latching Paradigm® 005

Round Rose



Exterior



Interior

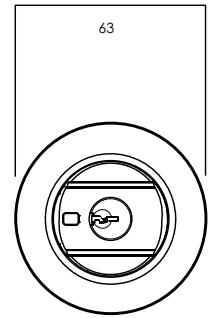
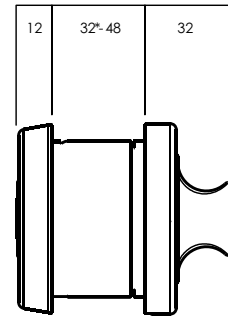
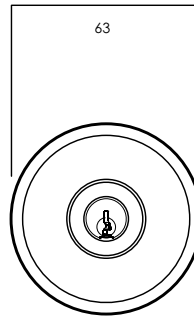

*32-36mm door thickness requires spacer ring (included)



Kinetic Defence®
Bump and pick resistant.



Door Thickness
32mm-48mm



SafetyRelease™
Minimises the risk of being locked in.



2 Keys Included
Can be keyed alike to other Lockwood door locks.



Retrofittable
Replace your existing Deadlatch.
Fits 54mm hole. 60mm backset.
32-48mm door thickness.



Holdback Mode
Keep the latch in the retracted position when required.



Safety Mode
Securely locked from outside and free from inside.



Secure Mode
Securely locked from both inside and outside. For when nobody is home.

Latching Paradigm® 005

Ordering Procedure

Series 005	Type L	Rose Style 1	Finish SP	Packaging DP	Keying
Series Paradigm® 005		Rose Style Round 1		Packaging Universal Pack DP	
Type Latch L		Finish Satin Chrome Pearl SP Chrome Plate CP		Keying Options Special Keying-Residential Keyed Alike 5P 5KA Keyed Alike 6P 6KA Project Keyed 5P 5PK Project Keyed 6P 6PK Restricted Profile 5P 5RP	
* For keying options please contact customer service.					



The Australian designed Paradigm® Pull Handle Lockset expresses superior state-of-the-art design featuring a contemporary style that delivers exceptional safety and security.

Suitable for residential, new building and renovation market applications.

The Pull Handle lockset incorporates innovative safety features from the Paradigm 005 Deadbolt and is manufactured with high end 304 grade stainless steel that comes in a brushed satin finish.

Key Features

- Three function modes with DualSelect® provides combination of convenience and security
- High security cut resistant stainless steel bolt
- Brushed 304 Grade Stainless Steel Pull Handles
- Concealed screw fixings gives a neat and clean appearance
- Safety Release™ automatically unlocks internal knob upon key entry from outside
- LockAlert® indicator shows lock status at a glance

Restricted Special Keying

Lockwood locks can be keyed to a number of controlled and/or specially keyed systems. These range from legally protected keys to protect against unauthorised duplication, which can also include specially designed key systems such as master key systems, which allow for different levels of mechanical access control.

Please refer to Lockwood Keying Catalogue or contact your local sales office or customer service for specific information.

Product Details

Dimensions	External handle length - 600mm Internal handle length - 500mm Handle width - 30mm
Backset	60mm-70mm adjustable
Bolt	High security cut resistant
Cylinder	5 pin tumbler mechanism Brass cylinder and brass barrel
Door Thickness	32 - 48mm 32-36mm doors require a spacer (Included)
Finishes	Satin Stainless Steel (SSS)
Materials	304 Grade Stainless Steel
Strike	Box strike with concealed crossgrain door frame strengthening screw
Magnets	Door Magnets included to hold the door(s) in position when in passage mode (free to enter from outside and free to exit from inside)
Keying	<ul style="list-style-type: none"> • Supplied individually keyed with two keys per lock • 78,000 key combinations • Key blank KB401B5P

Standards and Compliance

SL8	(Security) Australian Lock Standard (AS4145.2 - 2008)
D8	(Durability) Australian Lock Standard (AS4145.2 - 2008)
C6	(Corrosion) Australian Lock Standard AS4145.2 - 2008)
K5	(Key Security) Australian Lock Standard AS4145.2 - 2008)



Exterior

Interior

Pull Handle Lockset

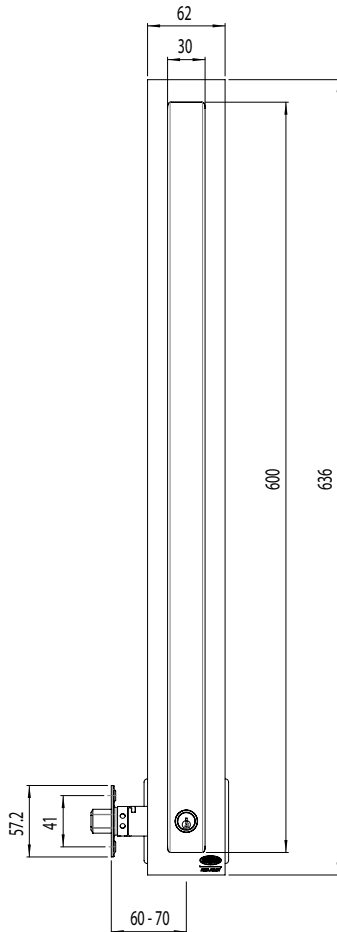

Exterior View

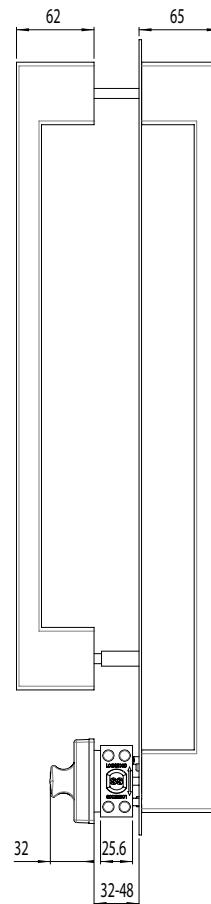

Door Thickness

Side View

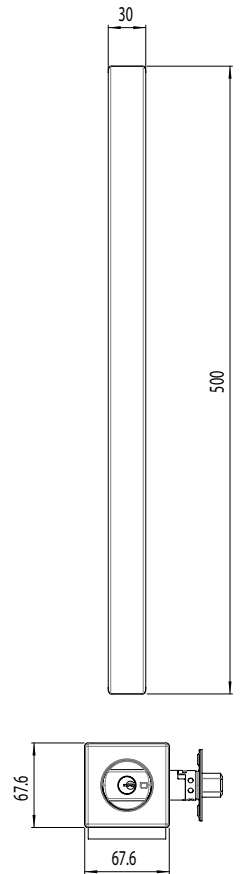

Interior View



DualSelect®
Turn the key for safety mode. Turn the key further to select secure mode.



SafetyRelease™
Minimises the risk of being locked in.



Corrosion Resistant
Successfully tested in accordance with AS2332.3.1:2001 neutral salt spray test.



Kinetic Defence®
Bump and pick resistant.



Counterbalance Bolt
Proportionally distributes the load between the door and door frame.



2 Keys Included
Can be keyed alike to other Lockwood door locks.



Door Thickness
32mm to 48mm.



LockAlert™
Interior Indicator shows lock status at a glance.



Safety Mode
Securely locked from outside and free from inside.



Secure Mode
Securely locked from both inside and outside. For when nobody is home.



Passage Mode
Free to enter from outside and free to exit from inside.

Paradigm® Pull Handle Lockset - Deadlatch



Interior View - Single Cylinder Shown



The Australian designed Paradigm® Pull Handle Lockset expresses superior state-of-the art design featuring a contemporary style that delivers exceptional safety and security. The Paradigm® Pull Handle latching lockset is available in single and double cylinder variants.

Both variants are specifically designed for semi-commercial and apartment building applications. The locksets have been successfully tested up to 2 hours (depending on the type of doorset) on fire assemblies in accordance with Australian Standard AS1905.1-2005, part 1: Fire Resistant Doorset.

The Pull Handle lockset applies the innovative safety features from the Paradigm 005 Deadbolt into a latching lockset and is manufactured with high end 304 grade stainless steel that comes in a brushed satin finish.

Key Features

- High security cut resistant Stainless Steel latch
- Brushed 304 grade Stainless Steel Pull Handle
- Concealed screw fixings for a neat and clean appearance
- Safety Release™ automatically unlocks internal knob upon key entry from outside*
- LockAlert® indicator shows lock status at a glance*

*Only available in double cylinder variant

Restricted Special Keying

Lockwood locks can be keyed to a number of controlled and/or specially keyed systems. These range from legally protected keys to protect against unauthorised duplication, which can also include specially designed key systems such as master key systems, which allow for different levels of mechanical access control.

Please refer to Lockwood Keying Catalogue or contact your local sales office or customer service for specific information.

Product Details

Dimensions	External handle length - 600mm Internal handle length - 500mm Handle width - 30mm
Backset	60mm
Latch	High security cut resistant Stainless Steel deadlatch
Cylinder	5 pin tumbler mechanism Brass cylinder and brass barrel
Door Thickness	32-48mm 32-36mm require a spacer (included)
Finishes	Satin Stainless Steel (SSS)
Materials	304 Grade Stainless Steel
Keying	<ul style="list-style-type: none"> • Supplied individually keyed with two keys per lock • 78,000 key combinations • Key blank KB401B5P

Standards and Compliance



The Paradigm Pull Handle latching Lockset has been successfully tested up to 2 hours (depending on the type of doorset) on fire assemblies in accordance with Australian Standard AS1905.1-2005, part 1: Fire Resistant Doorset for commercial applications.

SL7	(Security) Australian Lock Standard (AS4145.2 - 2008)
D8	(Durability) Australian Lock Standard (AS4145.2 - 2008)
C6	(Corrosion) Australian Lock Standard AS4145.2 - 2008)
K5	(Key Security) Australian Lock Standard AS4145.2 - 2008)

Paradigm® Pull Handle Lockset - Deadlatch

Pull Handle Lockset



Exterior Interior Double Cylinder Interior Single Cylinder

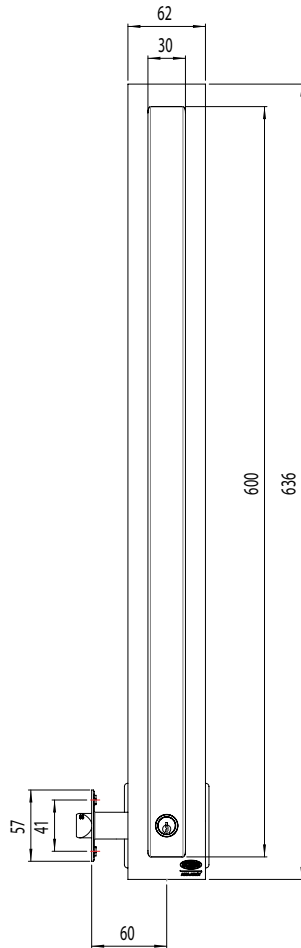

Exterior View

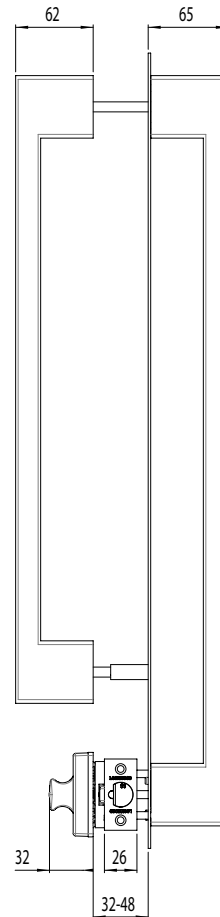

Door Thickness

Side View

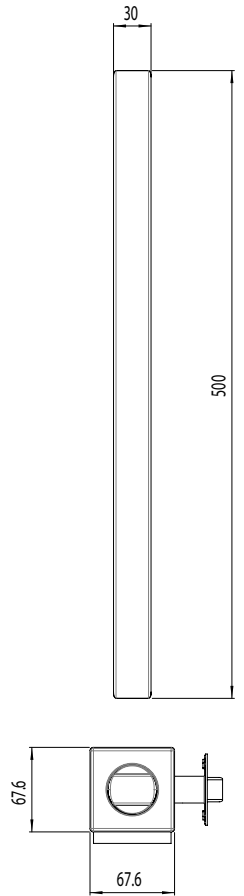

Interior View (Single Cylinder)



SafetyRelease™*
Minimises the risk of being locked in.



Door Thickness
32mm to 48mm.



LockAlert®*
Interior Indicator shows lock status at a glance.



Kinetic Defence®
Bump and pick resistant.



2 Keys Included
Can be keyed alike to other Lockwood door locks.



Safety Mode
Securely locked from outside and free from inside.



Corrosion Resistant
Successfully tested in accordance with AS2332.3.1:2001 neutral salt spray test.



Secure Mode*
Securely locked from both inside and outside. For when nobody is home.

* Not available for Single Cylinder variant

Paradigm® Pull Handle Lockset - Dummy Handle



Interior View - Double Cylinder Lockset
with Dummy Handle Shown

The Australian designed Paradigm® Pull Handle Lockset expresses superior state-of-the-art design featuring a contemporary style that delivers exceptional safety and security. The Paradigm® Dummy Handle is designed to be used alongside the Paradigm Pull Handle lockset in double door applications.

Manufactured with high end 304 grade Stainless Steel that comes in a brushed satin finish, the Paradigm Dummy Handle provides premium quality with contemporary styling for modern double door entrances.

Key Features

- Brushed 304 grade Stainless Steel Pull Handle
- Concealed screw fixings for a neat and clean appearance

Product Details

Dimensions	External handle length - 600mm Internal handle length - 500mm Handle width - 30mm
Door Thickness	32-48mm
Finishes	Satin Stainless Steel (SSS)
Materials	304 Grade Stainless Steel

Paradigm® Pull Handle Lockset - Dummy Handle



Exterior

Interior

Dummy Handle

(Non-functioning) for double door application.

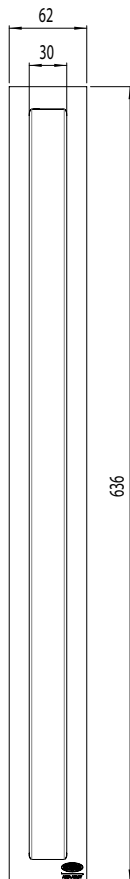

Exterior View

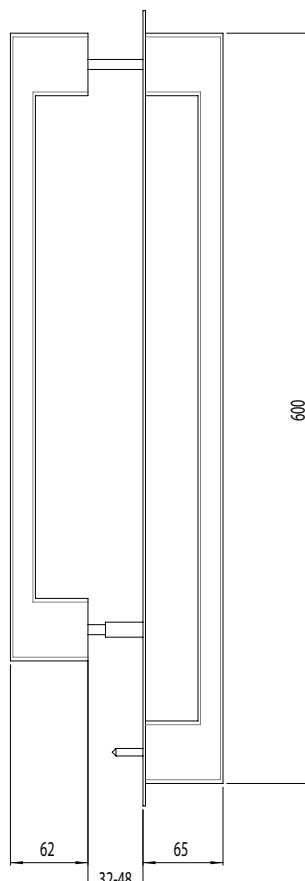

Door Thickness

Side View

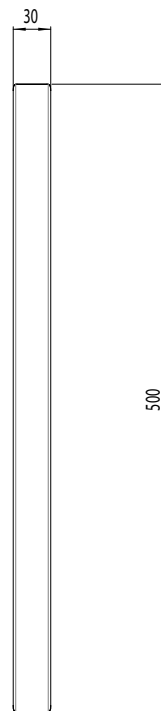

Interior View



Corrosion Resistant

Successfully tested in accordance with AS2332.3.1:2001 neutral salt spray test.



Door Thickness

32mm to 48mm.

Paradigm® Pull Handle Locksets

Ordering Procedure

Sample part number 005/DPHBSSS5PK is made up of several sections. Choose your product by selecting an option from each section.

Paradigm® Pull Handle Locksets

Series	Type	Finish	Keying
005	DPHL	SSS	5PK

Series
Paradigm® Pull Handle 005

Type
Double Cylinder Deadbolt DPHB
Double Cylinder Deadlatch DPHL
Single Cylinder Deadlatch SPHL
Dummy Handle PHD

Finish
Satin Stainless Steel SSS

Keying Options
Keyed to Differ (Standard)
Special Keying-Residential Keyed Alike 5P 5KA
Keyed Alike 6P 6KA
Project Keyed 5P 5PK
Project Keyed 6P 6PK
Restricted Profile 5P 5RP

Symmetry® Deadbolt



Description

The Symmetry general purpose Deadbolts are standard security products that should be fitted with a Key in Knob or Key in Lever lockset for added safety and security.

Keying

- Supplied individually keyed with two keys per lock
- 78,000 key combinations
- Key blank KB401B5P

Restricted Special Keying

Lockwood locks can be keyed to a number of controlled and/or specially keyed systems. These range from legally protected keys to protect against unauthorised duplication, which can also include specially designed key systems such as master key systems, which allow for different levels of mechanical access control.

Please refer to Lockwood Keying Catalogue or contact your local sales office or customer service for specific information.

Bolt Dimensions

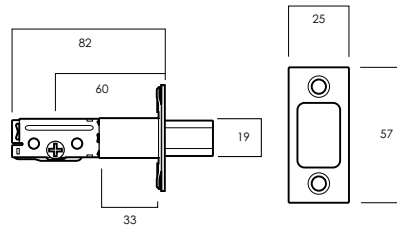

Retrofitable

Replace your existing Deadbolt. Fits 54mm hole. 60-70mm adjustable backset. 31-45mm door thickness.

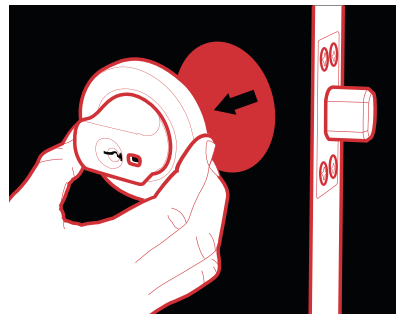

Product Details

Backset	60mm to 70mm adjustable bolt
Bolt	Solid brass bolt with 25mm projection. Hardened insert in locking bolt
Cylinder	The one cylinder assembly solution "OneCyl®" has been designed for the Lockwood Symmetry Range, which grants the convenience of cylinder interchangeability. C4 brass cylinder assembly (6 pin compatible)

Symmetry Everbrass® Guarantee



Lockwood Everbrass® product is coated both on the exterior and interior surfaces with a lifetime anti-tarnish finish. Lockwood warrants that Everbrass® branded product will not corrode, tarnish or discolour for a lifetime when properly installed and subject to no more than fair wear and tear.

Symmetry 5 Year Finish Guarantee



Lockwood guarantees to replace Symmetry product if within five years from the proven date of purchase it tarnishes, discolours or corrodes when properly installed and subject to no more than fair wear and tear.

Symmetry® Deadbolt

Single Cylinder



Exterior



Interior

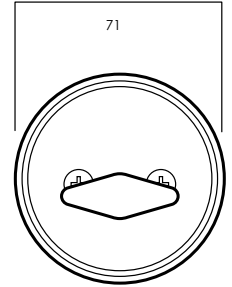
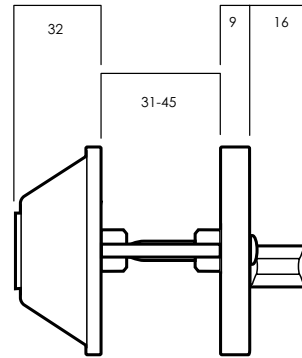
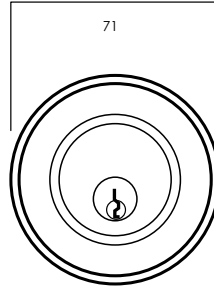

Kinetic Defence®
Bump and pick resistant.



2 Keys Included
Can be keyed alike to other
Lockwood door locks.



Retrofitable
Replace your existing Deadbolt. Fits
54mm hole. 60-70mm adjustable
backset. 31-45 door thickness.

ONECYL® Cylinder Solution

Finish	Trade Pack	Display Pack
Polished Brass	7106PB	7106PBDP
Polished Stainless Steel	7106PSS	—
Satin Stainless Steel	7106SSS	7106SSSDP
Satin Chrome Brushed	7106SC	—

Product Details

Door Thickness	31mm to 45mm 31 to 41mm requires spacer ring (included)
Finishes	Polished Brass (PB) Polished Stainless Steel (PSS) Satin Stainless Steel (SSS) Satin Chrome Brushed (SC)
Handing	Suits left or right hand opening doors
Keying	Operated by key from outside and turn knob inside

Symmetry® Deadbolt

Double Cylinder



Exterior



Interior

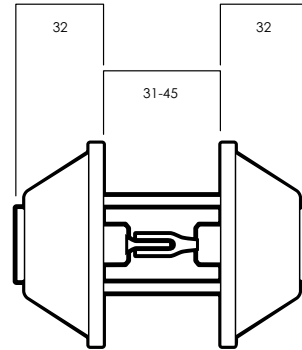
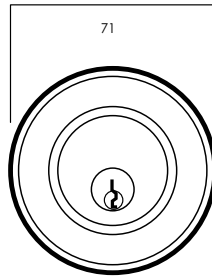

Kinetic Defence®
Bump and pick resistant.



2 Keys Included
Can be keyed alike to other
Lockwood door locks.



Retrofitable
Replace your existing Deadbolt. Fits
54mm hole. 60-70mm adjustable
backset. 31-45mm door thickness.

ONECYL® Cylinder Solution

Finish	Trade Pack	Display Pack
EverBrass	7107EVB	7107EVBDP
Polished Stainless Steel	7107PSS	7107PSSDP
Satin Stainless Steel	7107SSS	7107SSSDP

Product Details

Door Thickness	31mm to 45mm *31 to 41mm requires spacer ring (included)
Finishes	EverBrass (EVB) Polished Stainless Steel (PSS) Satin Stainless Steel (SSS)
Handing	Suits left or right hand opening doors
Keying	Operated by key from both inside and outside

Symmetry® Deadbolt - Accessory

Adjustable 60-70mm Backset Bolt

Part Number 7541ASSS

Finish Satin Stainless Steel

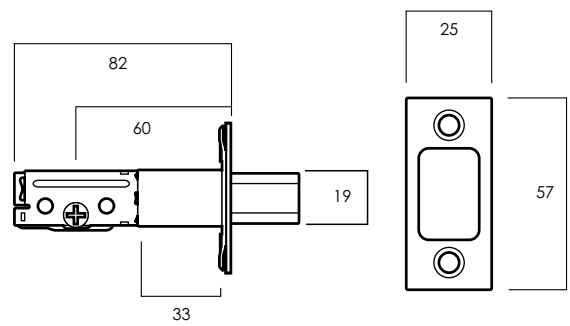



ASSA ABLOY

Lockwood is the leading brand in the Australian locking industry. With an established reputation for high quality products, this iconic brand provides a wide range of locking solutions to residential housing, commercial, semi-commercial, building and industrial application markets. Lockwood is supported by an extensive distribution and after-sales support network. Our customers include retailers, architects, trade and industrial personnel, locksmiths and security dealers.

ASSA ABLOY is the global leader in door opening solutions, dedicated to satisfying end-user needs for security, safety and convenience.

ASSA ABLOY is represented in all major regions, in both mature and emerging markets, with leading positions in Australia, Europe and North America.

**25YEAR
MECHANICAL
WARRANTY**

The Lockwood 25 Year Mechanical Warranty

Our belief that we manufacture the finest premium products available in today's market place is backed by the Lockwood 25 Year Mechanical Warranty, ensuring that Lockwood continues to keep Australians safe by delivering security and peace of mind.

For warranty terms and conditions, please visit www.lockweb.com.au or call **1300WARRANTY**

ASSA ABLOY Australia Pty Ltd
235 Huntingdale Road
Oakleigh, Victoria, 3166
Australia

1300 LOCK UP (1300 562 587)
lockweb.com.au

ASSA ABLOY New Zealand Ltd
6 Armstrong Road
Albany, Auckland, 0632
New Zealand

info.nz@assaabloy.com
Telephone +64 9415 7111
assaabloy.co.nz

Disclaimer

Whilst every effort has been made to ensure that the information (including product images and drawings) contained in this brochure is accurate at the time of publication, ASSA ABLOY Australia Pty Limited ("ASSA ABLOY") recommends that you consult ASSA ABLOY or its agents prior to placing an order to ascertain current information on specific products, as ASSA ABLOY reserves the right to make changes without notice. ASSA ABLOY will not be liable for any injury, loss or damage whatsoever, arising from any errors or omissions in the information contained in the brochure or arising from the use or application of the information contained herein. © 2017 copyright by ASSA ABLOY All rights reserved

