

home
**LOCKING &
DOOR HARDWARE**
SOLUTIONS

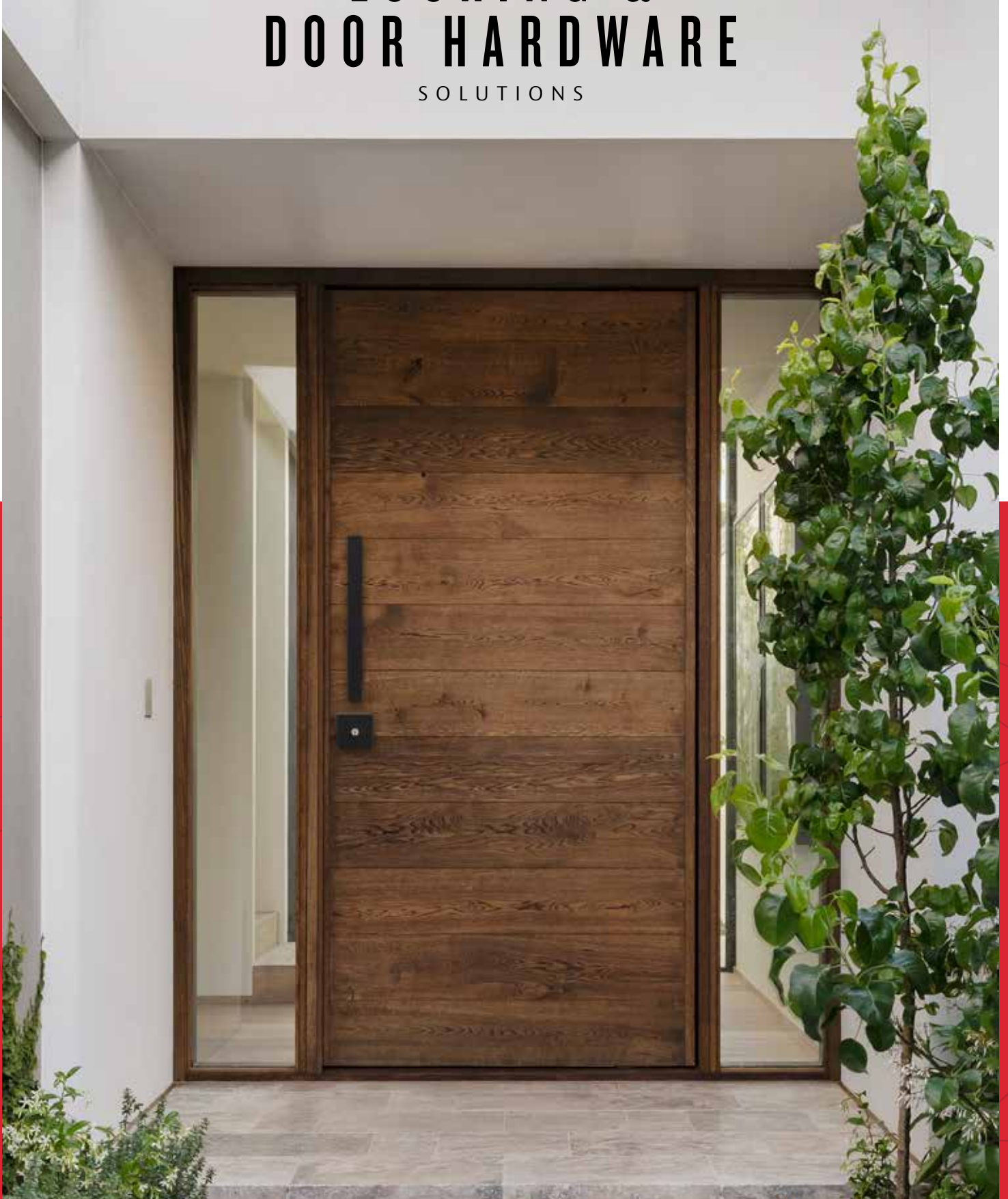

GET THE LOOK

What's your Style?

No matter if you're building a new home or renovating your current home, interior spaces should evoke a feeling of comfort; an oasis that you can retreat to. There are three emerging design styles which bring texture, luxury and warmth to Australian interior spaces: Biophilic Design, Japandi, and Sustainable Design.



Biophilic Design

Biophilic Design is a style that incorporates nature into the home to create calm and soothing spaces. Designers focus on natural materials such as stone, timber, plants and other natural elements.



Japandi Fusion

Japandi is a fusion of Scandinavian and Japanese design - uniting both styles, to create a serene, ordered and balanced living space. The focus is on a warmer, muted colour palette, organic and natural materials with an emphasis on natural lighting, compared to eternally popular Scandi which often features cooler, lighter tones.



Sustainable Design

As sustainability takes centre-stage, eco-friendly interior design is becoming increasingly popular. Australians are embracing recycled and upcycled furniture, sustainable materials, and energy-efficient appliances. From reclaimed wood furniture to energy-saving lighting options, there's a growing emphasis on creating environmentally conscious and socially responsible living spaces.

LEGEND

Select the right furniture for your door.



Entrance

External entry doors you would like to lock: Front Doors, Back Doors and Garage Doors.



Privacy Set

Interior doors you would like to lock: Bathroom, Study / Office and Bedrooms.



Passage Set

Interior doors you do not want to lock: Laundry, Living Room and Bedrooms.



Dummy Lever

To use on doors that are non operational: Closets and Wardrobes.

Finishes guide

BLK	Black
BRN	Brown
BZ	Bronze
CP	Chrome Plate
EVB	Everbrass
GM	Gum Metal
GSP	Gold
LSC	Brushed Satin Chrome
MAG	Magnolia
MBK	Matt Black
PB	Polished Brass
PRM	Primrose
PSS	Polished Stainless Steel
SB	Satin Brass
SC	Satin Chrome
SIL	Silver
SP	Satin Chrome Pearl
SSS	Stainless Steel
STB	Stone Beige
WH	White
WHB	White Birch

Additional information



QUICK INSTALL

Quick and easy to install for your next DIY home project.



HIRE A LOCKIE

Professional installation required. Visit our website to find a Locksmith near you!

www.lockweb.com.au/en/where-to-buy

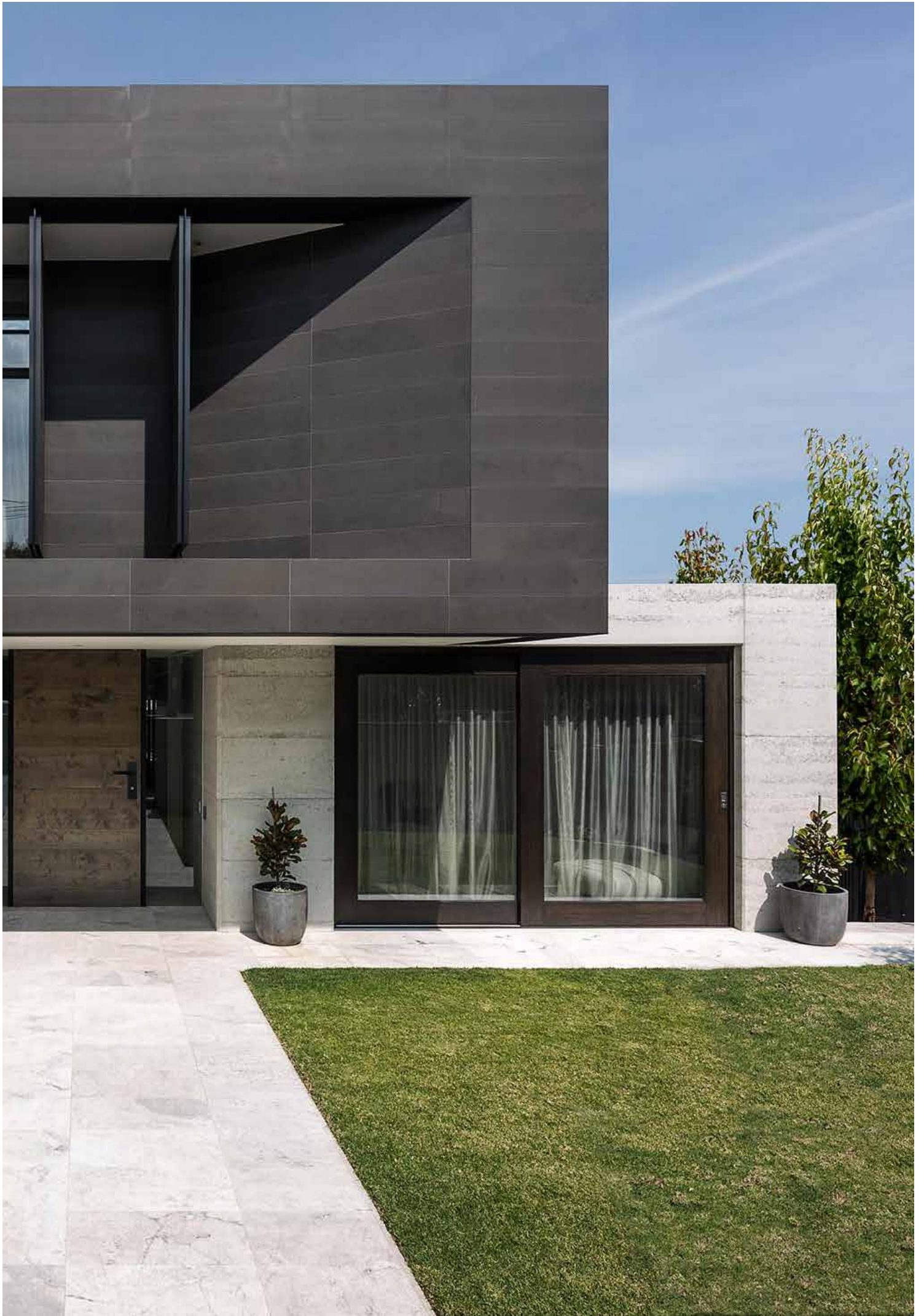



Contents

NERO® COLLECTION

001 Double Cylinder Deadlatch	8
Symmetry® 7107 Double Cylinder Deadbolt	9
355 Deadlock	9
Nexion® Mechanical Entrance Lockset	10
100 Nightlatch	11
Entrance Handle	12
Paradigm® 005 Double Cylinder Deadbolt	13
Latching Paradigm® 005	13
Paradigm® Pull Handle Lockset - Deadbolt	14
Velocity® Large Rose Series Element Lever	16
Velocity® Small Rose Series Leversets	18
Symmetry® -Element™ Leverset	20
Cavity Sliding Door Lock	21
FP2 Flush Pull	21

ENTRANCE SOLUTIONS

Velocity® Entrance Lockset	22
Nexion® Mechanical Entrance Lockset	23
Paradigm® 005 Double Cylinder Deadbolt	24
Latching Paradigm® 005	23
Symmetry Deadbolts	25
001 Double Cylinder Deadlatch	26
Deadlocks	26
Paradigm® Pull Handle Lockset	27
Entrance Handles	28

*For over 75 years, our guiding principle is
and will always be: To take the worry out
of protecting what is valuable to you.*

Lockwood: *no Worries*[®]



INTERIOR SOLUTIONS

Vivid [®] Collection Internal Door Leversets	30
Vivid [®] Collection Privacy Cavity Door Slider	31
Vivid [®] Collection Door Stops	31
Vivid [®] Collection Sliding Door Flush Pulls	32
Vivid [®] Cavity Sliding Door Edge Pulls	33
Vivid [®] Door Hinges	33
Velocity [®] Large Rose Series Element Lever	34
Velocity [®] Small Rose Series Leversets	36
Symmetry Door Handle Range	37

SLIDING DOOR SOLUTIONS

Cavity Sliding Door Locks	38
Onyx Patio Sliding Door Lock	40
Hinged & Sliding Security Screen Door Locks	41
Hydraulic Screen Door Closer	42



001 Double Cylinder Deadlatch

Features

- Conforms to the security and durability requirements of Australian Standard AS4145.2-2008 | Si7D8C6
- Cut-resistant Stainless Steel Bolt
- 11 concealed anchorage points and a door frame strengthener that combine to offer high security protection
- Hold back function that allows you to use the door in passage mode
- Patented LockAlert® and SafetyRelease™ functions
- Suitable for both INWARD opening timber and metal framed doors*.

* 001-1K1 is for timber framed doors and 001-3K1 is for metal framed doors.



001-1K1MBK
Interior View



Exterior View



001-3K1MBK
Interior View



Exterior View

Symmetry® 7107 Double Cylinder Deadbolt

Features

- Entry-level deadbolt offers standard security
- Suits left or right hand opening doors
- Solid brass bolt with 25mm projection
- Hardened insert in locking bolt
- Double cylinder configuration only available in matt black finish
- Suited to compliment Lockwood Symmetry knob and lever locksets

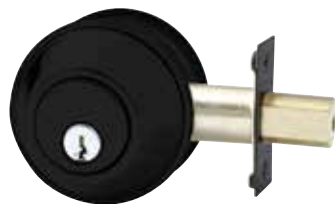

7107MBKDP
Exterior View

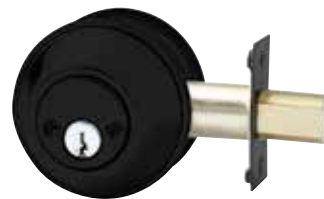

7107MBKDP
Interior View



355-NMBK
Interior View



Exterior View

355 Deadlock

Features

- Lockable turn knob with inbuilt clutching device to resist wrench attack.
- Can be opened by key from outside and by turn knob from inside.
- Suitable door types include: single hinged door, single sliding door, pair timber hinged doors and pair timber sliding doors. Glazed doors require minimum side rail.
- Conforms to Australian Standard AS4145.2-2008 SL7D8C6.





Nexion® Mechanical Entrance Lockset

Features

- SafetyRelease™ automatically unlocks the inside handle upon entry to minimise the risk of being locked in
- LockAlert® indicator shows lock status at a glance
- Three modes of security: Secure, Safety and Passage mode provides excellent security without compromising convenience
- Designed to be keyed to builder's key systems as well as keyed alike to other Lockwood door locks
- Conforms to Australian Standard AS4145.2-2008 S_i7D8C5K6



NXV12/1L3MBK
Exterior View



NXV12/1L3MBK
Interior View

100 Nightlatch

Features

- Opened by key from outside and by turn knob inside
- Bolt may be held back by turning knob in clockwise direction

Keying

- Supplied individually keyed with two keys per lock
- 78,000 key combinations
- Key blank KB401B5P

Restricted Special Keying

Lockwood locks can be keyed to a number of controlled and/or specially keyed systems. These range from legally protected keys to protect against unauthorised duplication, which can also include specially designed key systems such as master key systems, which allow for different levels of mechanical access control.

Please refer to Lockwood Keying Catalogue or contact your local sales office or customer service for specific information.



Interior View



Exterior View





Entrance Handles

Features

- Constructed of 304 grade stainless steel
- Suitable for use in both internal and external environments
- Disabled Accessible: AS1428.1 Compliant
- Supplied with spigots to suit 10-12mm thick glass doors as well as aluminium and timber doors up to 50mm thick

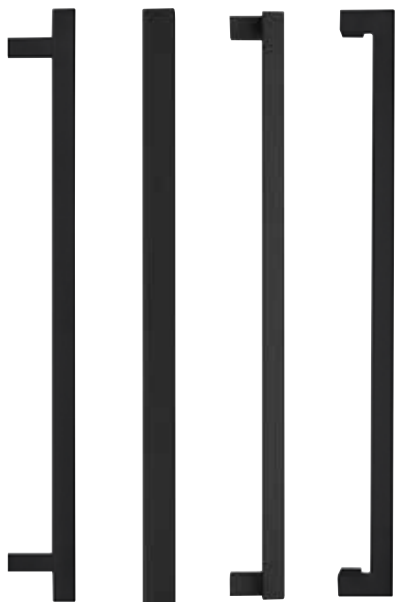

145X225MBK

146X450MBK
146X600MBK

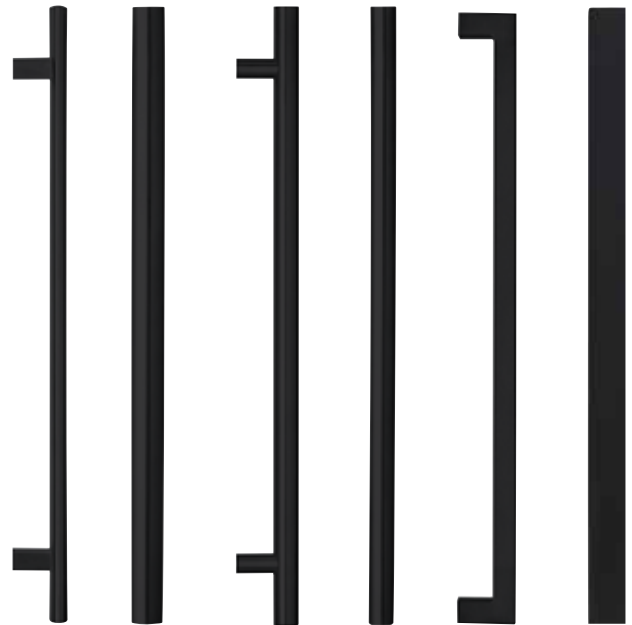

141X300MBK
141X600MBK

142X300MBK
142X450MBK

143X450MBK
143X600MBK

Paradigm® 005 Double Cylinder Deadbolt

Features

- Simple to install, retrofits existing deadbolt door preparations
- SafetyRelease™ automatically unlocks internal turn knob upon key entry from outside
- LockAlert® indicator shows lock status at a glance. The lockset can operate in three modes: Secure Mode, Safety Mode and Passage Mode
- DualSelect® function - turn the key for safety mode, turn the key further to select secure mode
- Conforms to the security and durability requirements of Australian Standard AS4145.2-2008 | SL8D8C6K5



005/B1MBKDP
Round Rose
Exterior View



005/B1MBKDP
Round Rose
Interior View



005/B2MBKDP
Square Rose
Exterior View



005/B2MBKDP
Square Rose
Interior View

Latching Paradigm® 005

Features

- Three function modes provides perfect combination of convenience and security
- High security cut resistant stainless steel latch
- Safety Release™ automatically unlocks internal knob upon key entry from outside



005L/B1MBKDP
Round Rose
Exterior View



005L/B1MBKDP
Round Rose
Interior View



NERO® COLLECTION
ENTRANCE



Paradigm® Pull Handle Lockset - Deadbolt

Features

- Conforms to the security and durability requirements of Australian Standard AS4145.2-2008 | S18D8C6K5
- High security cut resistant Stainless Steel bolt for added security
- 304 grade Stainless Steel Pull Handle in a sleek Matt Black finish
- Door Magnets included to hold the door(s) in position when it is in passage mode (Deadbolt version only)
- Concealed screw fixings provide a neat and clean appearance

Finishes

SSS | MBK*

*Nero collection Paradigm® Pull Handle Lockset Cylinder Deadbolt available in Matt Black



005/DPHMBK
Exterior View



005/DPHMBK
Interior
Double Cylinder
- Deadbolt





QUICK INSTALL



Velocity® Series Leversets

Features

- Velocity Large Rose Series is suitable for retrofit and common residential door preparations. The roses fit 50mm or 54mm diameter holes.
- Velocity Small Rose Series 55mm roses fit up to 45mm door preparations commonly used with mortice locks or latches.
- Velocity Small Rose Series is successfully tested up to 2 hours on fire door assemblies with the Australian Standard AS1905.1 2005 - Part 1: Fire Resistant Doorsets when used with Lockwood Synergy or Selector mortice locks
- Velocity Small Rose Series also includes range of escutcheons such as a AS1428.1 compliant turnknob, standard turnknob and privacy indicating emergency turn.

Large Rose Dimensions 63mm by 12.5mm - Round Rose
65mm by 12.5mm - Square Rose

Small Rose Dimensions 55mm by 12.5mm - Round Rose
58mm by 12.5mm - Square Rose

Simple twist and tighten fixing method with pre-assembled lever set allows for super easy and fast installation



Velocity® Large Rose Series Leversets

The Large Rose of 63mm is the ideal size for replacing existing handles, and covering paint lines on doors.



Round Rose Passage Set
VEL1/L3MBK
63mm Round Rose



Round Rose Privacy Set
VEL2/L3MBK
63mm Round Rose



Round Rose Dummy Handle
VEL3/L3MBK
63mm Round Rose



Round Rose Passage Set
VEL1/37MBK*
65mm Square Rose



Round Rose Privacy Set
VEL2/37MBK*
65mm Square Rose



Square Rose Passage Set
VEL1/L3MBK + VES1-TRIMMBK
65mm Square Rose



Square Rose Privacy Set
VEL2/L3MBK + VES2-TRIMMBK
65mm Square Rose

NOTE: Square trims sold separately
(VES1-TRIMMBK and VES2-TRIMMBK).

*Available in display pack only



Velocity® Small Rose Series Leversets

The Small Rose is designed primarily for new installations and is available in Round Rose of 55mm or Square Rose of 58mm.



Round Rose Mortice Set
VSR0/L3MBK
55mm Round Rose



Square Rose Passage Set
VSR1/L3MBK + VSS1-TRIMMBK
58mm Square Rose

Round Rose Passage Set
VSR1/L3MBK

Round Rose Dummy Handle
VSR3/L3MBK



Round Rose Privacy Set
VSR2/L3MBK
55mm Round Rose



Square Rose Privacy Set
VSR2/L3MBK + VSS2-TRIMMBK
58mm Square Rose



Round Rose Mortice Set
VSR0/L8MBK
55mm Round Rose



Square Rose Passage Set
VSR1/L8MBK + VSS1-TRIMMBK
58mm Square Rose



Round Rose Passage Set
VSR1/L8MBK

Round Rose Privacy Set
VSR2/L8MBK



Round Rose Dummy Handle
VSR3/L8MBK
55mm Round Rose



Square Rose Privacy Set
VSR2/L8MBK + VSS2-TRIMMBK
58mm Square Rose



NOTE: Square trims sold separately (VSS1-TRIMMBK and VSS2-TRIMMBK).



Velocity® Small Rose Series Escutcheons



Euro Profile Cylinder Escutcheon
VSR5/MBK
55mm Round Escutcheon



Oval Cylinder Escutcheon
VSR6/MBK
55mm Round Escutcheon



Standard Turnknob
VSR7/MBK
55mm Round Escutcheon



Privacy Indicating Emergency Turn
VSR8/MBK
55mm Round Escutcheon



Disabled Accessible Turnknob
VSR9/MBK
55mm Round Escutcheon

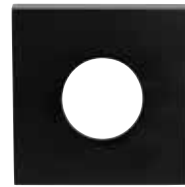

Square Rose Escutcheon Trim
VSS6-TRIMMBK
58mm Square Escutcheon

Designed for semi-commercial and residential applications, this range can be used with commercial mortice locks in addition to having passage, privacy and dummy leversets.



Symmetry® Element™ Leverset

Features

- All products are tested in accordance with the security and durability requirements of the Australian Standards.
- Lockwood guarantees to replace Symmetry product if within five years from the proven date of purchase it tarnishes, discolours or corrodes when properly installed and subject to no more than fair wear and tear.
- The exclusive one cylinder assembly solution 'OneCyl®' has been designed for the entire Lockwood Symmetry Range, which grants the convenience of cylinder interchangeability.

Entrance Set



7550MBK

Passage Set



7551MBK

Privacy Set



7552MBK

Dummy lever



7555MBK

Cavity Sliding Door Locks

Features

- Fitted flush against the panel of the sliding door for full recess into the door cavity
- Easily fitted into a standard 54mm door preparation with a 60mm backset
- Retractable Door Pull for ease of use



Privacy Set

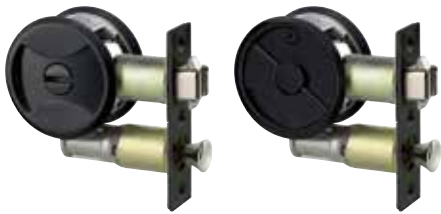

7400MBKDP
Exterior View

7400MBKDP
Interior View

Entrance Set

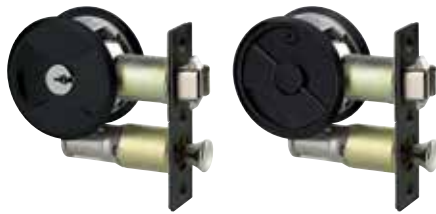

7444MBKDP
Exterior View

7444MBKDP
Interior View

Passage Set



7450MBKDP
Exterior View

7450MBKDP
Interior View



FP2-150MBK

FP2 Flush Pull

Features

- Fitted flush against the panel of the sliding door for full recess into the door cavity
- The internal edges of the flush pull handles are finished for comfort of use and to soften aesthetics.



ENTRANCE SOLUTIONS



Compliments Lever 3 Element™ in the Velocity Handle range.



Velocity® Entrance Lockset

Features

- High security latch
- Box strike with concealed crossgrain door frame strengthening screw
- Installation template included
- Can be keyed alike to other Lockwood door locks
- Retrofittable
- Complement the Velocity Door Handle range



VELO/L3SCDP
Exterior View



VELO/L3SCDP
Interior View

Easy installation, retrofits most common front door preparations.

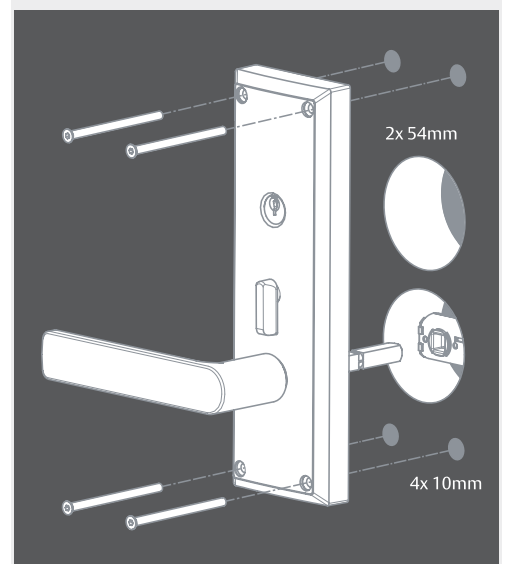

Nexion® Mechanical Entrance Lockset

Features

- SafetyRelease™ automatically unlocks the inside handle upon entry to minimise the risk of being locked in
- Lockout Release automatically unlocks the outside handle when the inside handle or snib is operated
- Factory set for left hand opening doors, easily changed for right hand opening doors.
- Can be keyed alike with other Lockwood door locks
- Conforms to Australian Standard AS4145.2-2008 S.7D8C5K6

Finishes

SC | SP | CP



Lever Selection



Summit® - L1



Spire® - L2



Element™ - L3



Glide™ - L4



Hakea® - 28



Saltbush® - 34



Paradigm® 005 Double Cylinder Deadbolt

Features

- Three function modes with DualSelect® provides perfect combination of convenience and security
- High security cut resistant stainless steel bolt
- Safety Release™ automatically unlocks internal knob upon key entry from outside
- LockAlert® indicator shows lock status at a glance

Finishes

Round Rose

EVB | SP | CP | SSS | LSC | MBK

Square Rose

SP | CP | LSC | MBK



005/B1SSSDP
Round Rose
Exterior View



005/B1SSSDP
Round Rose
Interior View



005/B2LSCDP
Square Rose
Exterior View



005/B2LSCDP
Square Rose
Interior View

Latching Paradigm® 005



005L/B1SCDP
Round Rose
Exterior View



005L/B1SCDP
Round Rose
Interior View

Features

- Three function modes provides perfect combination of convenience and security
- High security cut resistant stainless steel deadlatch
- Safety Release™ automatically unlocks internal knob upon key entry from outside

Finishes

SC | CP

* Nero Collection Latching Paradigm® 005 available in Matt black. Refer to page 13

Symmetry Deadbolts

Features

- Entry-level deadbolt offers standard security
- Suits left or right hand opening doors
- Solid brass bolt with 25mm projection
- Hardened insert in locking bolt
- Available in a single or double cylinder configuration
- Suited to compliment Lockwood Key in Knob and Key in Lever locksets

Finishes

Double Cylinder
EVB | PSS | SSS

Single Cylinder
PB | PSS | SC | SSS

* Nero Collection 7107 Double Cylinder Deadbolt available in Matt black. Refer to page 9.



Double Cylinder



7107PSS
Exterior View



7107PSS
Interior View

Single Cylinder



7106PSS
Exterior View



7106PSS
Interior View



001 Double Cylinder Deadlatch

Features

- Conforms to the security and durability requirements of Australian Standard AS4145.2-2008 | SL7D8C6
- Cut-resistant Stainless Steel Bolt
- 11 concealed anchorage points and a door frame strengthener that combine to offer high security protection
- Hold back function that allows you to use the door in passage mode
- Patented LockAlert® and SafetyRelease™ functions

Finishes

SP | CP | BRN | MBK*

* Nero Collection 001 Double Cylinder Deadlatch knob version available in Matt black. Refer to page 8.



001-1K1CPDP
Interior View

001-1L1CPDP
Interior View

Exterior View

Deadlocks

Features

- The 303 Single Cylinder Deadlock and 355 Double Cylinder Deadlock suits inward opening, and some sliding doors of 30-45mm thickness
- Both the 303 Single Cylinder Deadlock and 355 Double Cylinder Deadlock can be opened by key from outside and by turn knob from inside
- Suitable door types include: single hinged door, single sliding door, pair timber hinged doors and pair timber sliding doors. Glazed doors require minimum side rail.
- Conforms to Australian Standard AS4145.2-2008 SL7D8C6.

Finishes

303 Single Cylinder Deadlock

NSP

355 Double Cylinder Deadlock

EVB | BRN | CP | NSP | MBK

* Nero Collection 355 Double Cylinder Deadlock available in Matt black. Refer to page 9.



303 Single Cylinder Deadlock

355 Double Cylinder Deadlock



303-NSPDP
Interior View

355-NSPDP
Interior View

Exterior View

Paradigm® Pull Handle Lockset

Features

- Conforms to the security and durability requirements of Australian Standard AS4145.2-2008 | S:8D8C6K5
- High security cut resistant Stainless Steel bolt/latch
- Door Magnets included to hold the door(s) in position when it is in passage mode (Deadbolt version only)
- Concealed screw fixings provide a neat and clean appearance

Finishes

SSS | MBK*

*Nero collection Paradigm® Pull Handle Lockset
Cylinder Deadbolt available in Matt Black



*Exterior
View*

005/DPHBSSS
*Interior
Double Cylinder
- Deadbolt*

005/DPHSSS
*Interior
Single Cylinder
- Deadlatch*

005/PHDSSS
*Exterior / Interior
Dummy*

Entrance Handles

Features

- Handles available in different sizes
- Constructed of 304 grade stainless steel, Lockwood Entrance Handles are suitable for use in external environments
- Suitable for both residential and commercial markets

Finishes

SSS | MBK*

* Entrance handle series 141, 142, 143, 145 and 146 Styles are available in matt black and powder-coated finishes. Refer to page 11 for the selection.



151
300x200mm

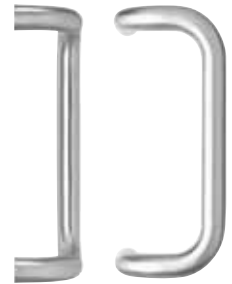

231
300x140mm



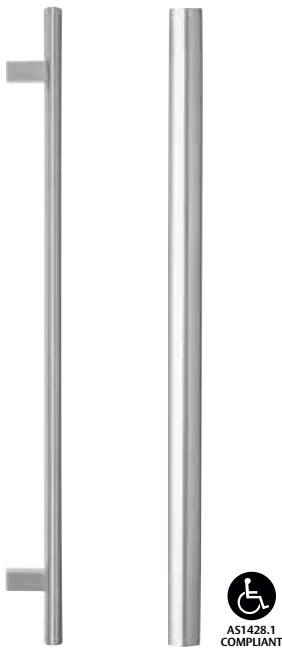

141
300x40mm*
450x40mm
600x40mm*

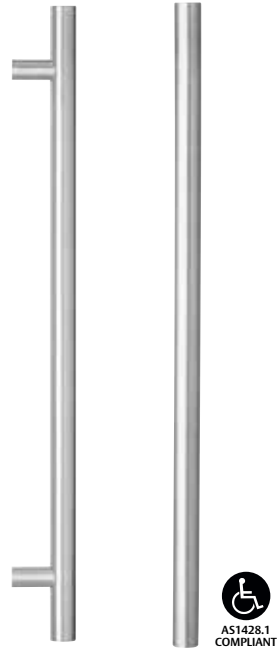

142
300x32mm*
450x32mm*
600x32mm

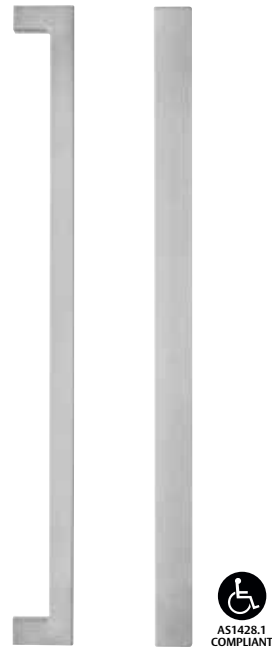

143
300x30mm
450x30mm*
600x30mm*

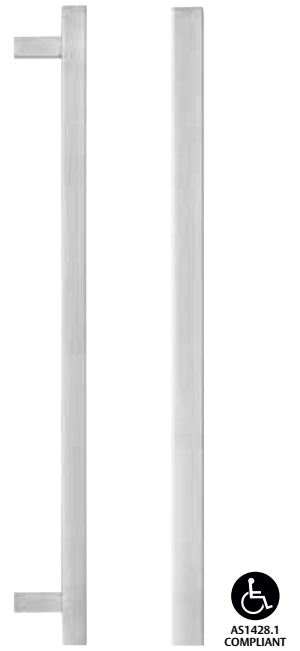

145
225x25mm*
375x25mm
425x25mm

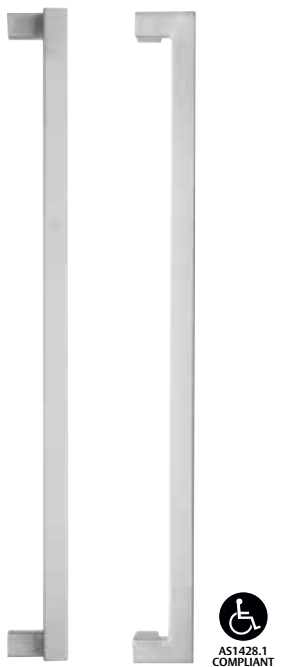

146
450x60mm*
600x60mm*



147
450x19mm



192
450x85mm
600x85mm



005*

* Refer to page 23 for additional information on the Paradigm® Pull Handle Lockset



The Vivid® Collection's three finishes - Satin Brass, Satin Bronze and Satin Gun Metal - are derived from a physical vapor deposition (PVD) surface treatment which offers a range of benefits, including sustainability and durability.

With the peace of mind that PVD provides, and the variety of coloured finishes to match any home décor style, Vivid® is the complete solution for renovators and new home builders alike.

Vivid® Collection Internal Door Leversets

Features

- All fixings are concealed beneath a removable rose trim providing an aesthetically appealing installation.
- Lever range includes two AS1428.1 compliant levers
- The 54mm rose suits up to 45mm door preparations

Finishes

SB | GM | BZ

* Nero Collection levers available in Matt black.
Refer to page 12 for selection.



LEVER 1 - PASSAGE / DUMMY



LEVER 2 - PASSAGE / DUMMY



LEVER 3 - PASSAGE / DUMMY



LEVER 4 - PASSAGE / DUMMY

Vivid® Collection Privacy Cavity Door Slider

Features

- The bolt can be released as a door pull to pull your door away from the cavity. Simply press the bolt to release
- Fitted flush against the panel of the sliding door for full recess into the door cavity

Finishes

SB | GM | BZ



PRIVACY CAVITY DOOR SLIDER
VIVCAV2/BZPVD



Vivid® Collection Door Stops

Features

- Walls are protected from furniture impacts and doors can be held open at any desired position
- The black rubber buffer gives further protection for door finishes
- Both floor and wall mount options available

Finishes

SB | GM | BZ



HALF MOON DOOR STOP
VIVA290/GMPVD



LONG CIGAR SHAPE
DOOR STOP
VIVA300/GMPVD



vivid.



Vivid® Collection Sliding Door Flush Pulls

Features

- Fitted flush against the panel of the sliding door for full recess into the door cavity
- The internal edges of the flush pull handles are finished for comfort of use and to soften aesthetics.

Finishes

SB | GM | BZ



150MM FLUSH PULLS

VIVFP2-150SBPVD

Vivid® Cavity Sliding Door Edge Pulls

Features

- Suited to numerous applications which require the door furniture to be flush with the edge of the door
- For any internal room where the door is fully pocketed into the wall cavity

Finishes

SB | GM | BZ



EDGE PULLS
VIVEP2/BZPVD



Vivid® Door Hinges

Features

- Suitable for regular internal doors, as they make it easier to remove the door from the frame for maintenance purposes
- Made from 304 stainless steel and have a typical metric pole pattern.

Finishes

SB | GM | BZ



LOOSE PIN HINGES
VIVLP/GMPVD



vivid.



Velocity® Series Leversets

Features

- Velocity Large Rose Series is suitable for retrofit and common residential door preparations. The roses fit 50mm or 54mm diameter holes.
- Velocity Small Rose Series 55mm roses fit up to 45mm door preparations commonly used with mortice locks or latches.
- Velocity Small Rose Series is successfully tested up to 2 hours on fire door assemblies with the Australian Standard AS1905.1 2005 - Part 1: Fire Resistant Doorsets when used with Lockwood Synergy or Selector mortice locks
- Velocity Small Rose Series also includes range of escutcheons such as a AS1428.1 compliant turnknob, standard turnknob and privacy indicating emergency turn.

Finishes

SC | CP | SP | MBK*

* Nero Collection levers available in Matt black. Refer to page 12 for selection.

Large Rose Dimensions 63mm by 12.5mm - Round Rose
65mm by 12.5mm - Square Rose

Small Rose Dimensions 55mm by 12.5mm - Round Rose
58mm by 12.5mm - Square Rose

Simple twist and tighten fixing method with pre-assembled lever set allows for super easy and fast installation



Velocity® Large Rose Series Leversets

The Large Rose of 63mm is the ideal size for replacing existing handles, and covering paint lines on doors.



VEL1/L1CP
Summit® - L1
63mm Round Rose



VEL1/L2CP
Spire® - L2
63mm Round Rose



VEL1/L3CP
Element™ - L3
63mm Round Rose



VEL1/L4CP
Glide - L4
63mm Round Rose



VEL1/28CP
Hakea® - 28
63mm Round Rose



VEL1/34CP
Saltbush® - 34
63mm Round Rose





Velocity® Small Rose Series Leversets

The Small Rose is designed primarily for new installations and is available in Round Rose of 55mm or Square Rose of 58mm.



VSR1/L1CP
Summit® - L1
55mm Round Rose



VSR1/L2CP
Spire® - L2
55mm Round Rose



VSR1/L3CP
Element™ - L3
55mm Round Rose



VSR1/L4CP
Glide - L4
55mm Round Rose



VSR1/L8CP
Dianella™ - L8
55mm Round Rose



VSR1/L1CP + VSS1-TRIMCP
Summit® - L1
58mm Square Rose



VSR1/L2CP + VSS1-TRIMCP
Spire® - L2
58mm Square Rose



VSR1/L3CP + VSS1-TRIMCP
Element™ - L3
58mm Square Rose



VSR1/L4CP + VSS1-TRIMCP
Glide - L4
58mm Square Rose

NOTE: Square trims sold separately.

Symmetry Door Handle Range

Features

- Suitable for left or right handed doors
- Can be keyed alike to other Lockwood door locks
- Suited for use with Lockwood Symmetry Deadbolts
- Available in Passage, Privacy and Dummy versions

Finishes Knobsets*

EVB | PB | PSS | SSS

Finishes Leversets*

CP | EVB | SC | PB



Symmetry Knobsets



7010PSS
Manor Entrance Knobset



7012PSS
Manor Privacy Knobset



7011PSS
Manor Passage Knobset



7020PSS
Imperial Entrance Knobset



7022PSS
Imperial Privacy Knobset



7021PSS
Imperial Passage Knobset

Symmetry Leversets



7540CP
District Entrance Leverset



7542CP
District Privacy Leverset



7541CP
District Passage Leverset



7530CP
Vicinity Entrance Leverset



7532CP
Vicinity Privacy Leverset



7531CP
Vicinity Passage Leverset



7550CP
Element Entrance Leverset



7552CP
Element Privacy Leverset



7551CP
Element Passage Leverset

* Products are available in different finishes.
Visit lockweb.com.au for more information.

SLIDING DOOR
SOLUTIONS



Cavity Sliding Door Locks

Features

- Fitted flush against the panel of the sliding door for full recess into the door cavity
- Easily fitted into a standard 54mm door preparation with a 60mm backset
- Retractable door pull for ease of use
- Australian standards compliance
AS4145.2-2008: Tested to exceed 30,000 turn cycles withstanding 3 kN of pull force

Finishes

SP | CP | MBK*

*Nero Collection Cavity Sliding Door Locks available in Matt black. Refer to page 17 for selection.

Privacy Set

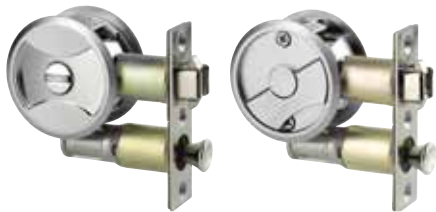

7400SP
Exterior View

7400SP
Interior View

Entrance Set

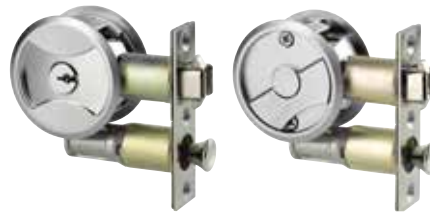

7444SP
Exterior View

7444SP
Interior View

Passage Set



7450SP
Exterior View

7450SP
Interior View

Passage Latch Set



7410SP
Exterior View

7410SP
Interior View



HIRE A LOCKIE

Onyx Patio Sliding Door Lock

Features

- Twin locking beaks for added security
- Door Close Detect button (DCD) anti slam feature protects locking beaks from accidental damage
- LockAlert® indicator shows lockset status at a glance
- DualSelect® enables two stage key locking
- Safety Release™ function minimises the risk of being locked in
- Ergonomic sliding snib with intuitive downward motion to unlock

Finishes

BLK | SIL | SP | WH



D Inner Handle

Slim Inner Pull

Slim Outer Pull

Universal Strike

Product Range: A wide selection of furniture options are available in the Onyx range to suit various sliding door applications. The range includes internal D handles and slim pulls and a variety of external furniture and strike options.

Hinged & Sliding Security Screen Door Locks

Features

- Designed to suit the standard 20mm hinged or sliding security door
- Both versions feature the unique DualSelect® functionality and are self-latching for improved home security
- Conforms to Australian Standard AS4145.2 2008, offering exceptional performance and reliability
- Lock from inside using snib
- Two keys available and can be keyed alike to other Lockwood door locks
- Suits left and right handed doors

Finishes

8653 Sliding Security Screen Door Lock

BLK | PRM | WH

8654 Hinged Security Door Lock

**BLK | BRN | CP
EVB | GSP | MAG
PRM | SP | STB
WH | WHB**



Inside



Inside

The 8653 Sliding Security Door Lock includes a **LockAlert®** indicator which shows the lock's status at a glance.



HIRE A LOCKIE



HIRE A LOCKIE

Hydraulic Screen Door Closer

Features

- Spring loaded piston in hydraulic unit for smooth closing
- Heavy duty, suits heavier screen doors, without being too strong for lighter doors
- Very high level of adjustability
- Closing speed easily hand adjustable, spinning entire cylinder
- Door hold-open feature
- Surface mounting
- Automatic latch operation

Finishes

BLK | SIL | WH



404BLK

NOTE: Length of closer is different to pneumatic closers; if replacing an older pneumatic closer, holes from original brackets will be in different locations.



Lockwood is the leading brand in the Australian locking industry. With an established reputation for high quality products, this iconic brand provides a wide range of locking solutions to residential housing, commercial, semi-commercial, building and industrial application markets. Lockwood is supported by an extensive distribution and after-sales support network. Our customers include retailers, architects, trade and industrial personnel, locksmiths and security dealers.



The Lockwood 25 Year Mechanical Warranty

Our belief that we manufacture the finest premium products available in today's market place is backed by the Lockwood 25 Year Mechanical Warranty, ensuring that Lockwood continues to keep Australians safe by delivering security and peace of mind.

For warranty terms and conditions, please visit www.lockweb.com.au or call **1300WARRANTY**

ASSA ABLOY Group is the global leader in access solutions. Every day, we help billions of people experience a more open world.

ASSA ABLOY Opening Solutions leads the development within door openings and products for access solutions in homes, businesses and institutions. Our offering includes doors, door and window hardware, mechanical and smart locks, access control and service.

Disclaimer: Whilst every effort has been made to ensure that the information (including product images and drawings) contained in this brochure is accurate at the time of publication, ASSA ABLOY Australia Pty Limited ("ASSA ABLOY") recommends that you consult ASSA ABLOY or its agents prior to placing an order to ascertain current information on specific products, as ASSA ABLOY reserves the right to make changes without notice. ASSA ABLOY will not be liable for any injury, loss or damage whatsoever, arising from any errors or omissions in the information contained in the brochure or arising from the use or application of the information contained herein. © 2022 copyright by ASSA ABLOY All rights reserved.

ASSA ABLOY Australia Pty Ltd ABN 90 086 451 907 ©2022_06 _AAA-CAT-041



ASSA ABLOY



**ASSA ABLOY Opening Solutions
Australia (Head Office)**

**235 Huntingdale Road
Oakleigh, Victoria, 3166 Australia**

**For customer feedback:
1300 LOCK UP (1300 562 587)
customerservice.au@assaabloy.com**

lockweb.com.au