





Latch Spindle			Locking Spindle		
Door Thickness (mm)	530, 532	534	Door Thickness (mm)	530, 532	534
40			40		
45		58	45		90
50	73	63	50	120	95
55	78	68	55	125	100
60	83	73	60	130	105
65	88	78	65	135	110
70	93	83	70	140	115
75	98	88	75	145	120
80	103	93	80	150	125
85	108	98	85	155	130
90	113	103	90	160	135
95	118	108	95	165	140
100	123	113	100	170	145
105	128	118	105	175	150
110		123	110		155
115		128	115		160
120		133	120		165
125			125		
130			130		
135			135		
140			140		
145			145		



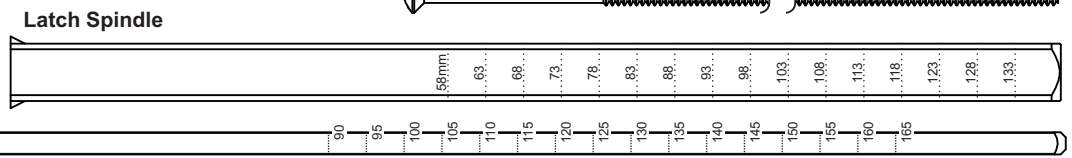
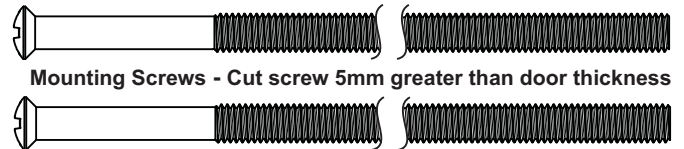

**530-6124SC Accessory Kit**  
Extended Spindle Kit for 530, 532, 534

- Step 1. - Establish product function
- Step 2. - Establish spindle type required
- Step 3. - Measure door thickness
- Step 4. - Establish spindle cut length as per the chart.  
Cut and deburr spindle to required cut length.
- Step 5. - Assemble new length spindle to lockset.

-  Use Standard Spindle.
-  Cut spindle length in millimetres.
-  No Cutting of Spindle required.
-  Door Thickness too large for this function.



Latch Spindle	
Door Thickness (mm)	531
40	
45	
50	
55	78
60	83
65	88
70	93
75	98
80	103
85	
90	
95	
100	
105	
110	
115	
120	
125	
130	
135	
140	
145	

-  Use Standard Spindle.
-  Cut spindle length in millimetres.
-  No Cutting of Spindle required.
-  Door Thickness too large for this function.

**531-6124SC Accessory Kit**  
Extended Spindle Kit for 531



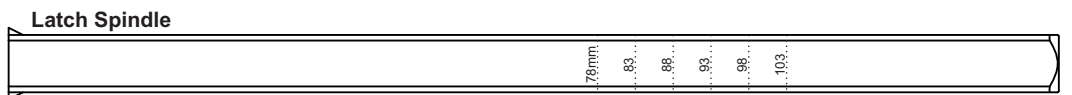
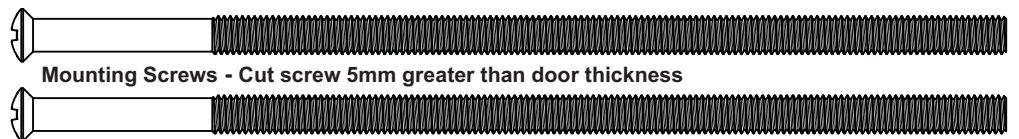

- Step 1. - Measure door thickness
- Step 2. - Establish spindle cut length as per the chart.  
Cut and deburr spindle to required cut length.
- Step 3. - Assemble new length spindle to lockset.



Latch Spindle			
Door Thickness (mm)	536	936, 956	536/936 combo
40			
45		80	
50		85	
55		90	
60	100	95	
65	105	100	105
70	110	105	110
75	115	110	115
80	120	115	120
85	125		125
90			130
95			135
100			
105			
110			
115			
120			
125			
130			
135			
140			
145			

**936-6124SC or 536-6124SC Accessory Kit**  
Extended Spindle Kit for 936, 956, 536, 536/936 Combo

- Step 1. - Establish product function
- Step 2. - Measure door thickness
- Step 3. - Establish spindle cut length as per the chart.  
Cut and deburr spindle to required cut length.
- Step 4. - Assemble new length spindle to lockset.

-  Use Standard Spindle.
-  Cut spindle length in millimetres.
-  No Cutting of Spindle required.
-  Door Thickness too large for this function.

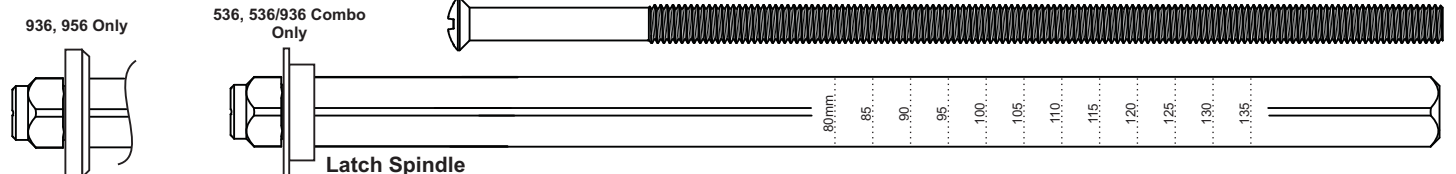
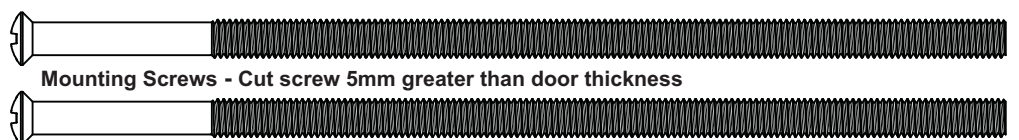

Latch Spindle		
Door Thickness (mm)	538	931, 951
40		
45		
50		
55	103	
60	108	
65	113	
70	118	
75	123	
80	128	
85	133	
90	138	
95	143	
100		
105		
110		
115		
120		
125		
130		
135		
140		
145		

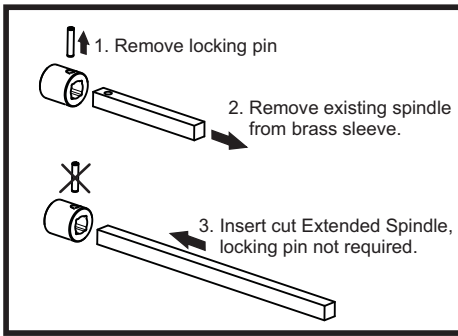

## 931-6124SC Accessory Kit

### Extended Spindle Kit for 538, 931, 951

- Step 1. - Establish product function
- Step 2. - Measure door thickness
- Step 3. - Establish spindle cut length as per the chart. Cut and deburr spindle to required cut length.
- Step 4. - Assemble new length spindle to lockset.

- Use Standard Spindle.
- Cut spindle length in millimetres.
- No Cutting of Spindle required.
- Door Thickness too large for this function.

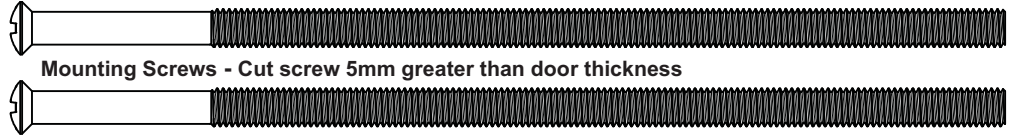

Latch Spindle

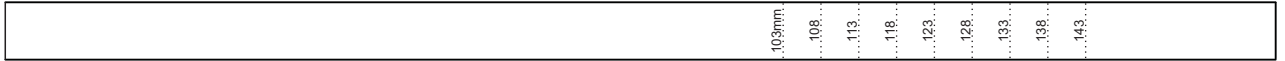

Spindle		
Door Thickness (mm)	938, 958	538/938 Combo
40		
45		88
50		93
55	83	98
60	88	103
65	93	108
70	98	113
75	103	118
80	108	123
85		
90		
95		
100		
105		
110		
115		
120		
125		
130		
135		
140		
145		

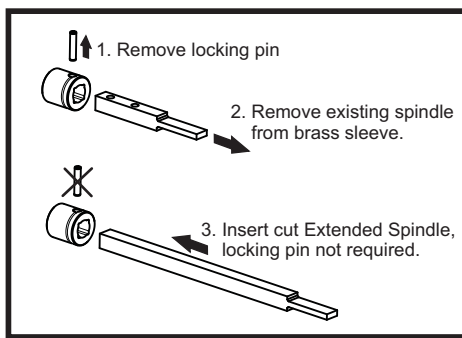

## 938-6124SC Accessory Kit

### Extended Spindle Kit for 938, 958, 538/938

- Step 1. - Establish product function
- Step 2. - Measure door thickness
- Step 3. - Establish spindle cut length as per the chart. Cut and deburr spindle to required cut length.
- Step 4. - Assemble new length spindle to lockset.

- Use Standard Spindle.
- Cut spindle length in millimetres.
- No Cutting of Spindle required.
- Door Thickness too large for this function.

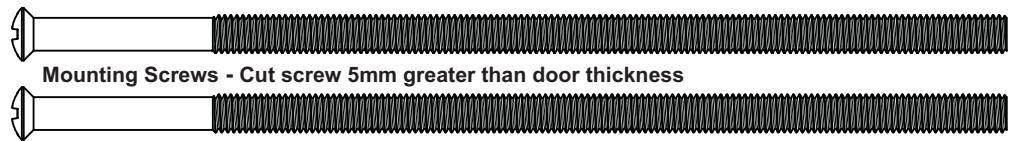

Spindle



Latch Spindle			
Door Thickness (mm)	529	929, 949, 930, 932, 950, 952	934, 954
40			50
45		65	55
50	85	70	60
55	90	75	65
60	95	80	70
65	100	85	75
70	105	90	80
75	110	95	85
80	115	100	90
85	120	105	95
90		110	100
95			105
100			110
105			115
110			120
115			125
120			130
125			135
130			
135			
140			
145			

Locking Spindle			
Door Thickness (mm)	529	929, 949, 930, 932, 950, 952	934, 954
40			75
45		95	80
50	120	100	85
55	125	105	90
60	130	110	95
65	135	115	100
70	140	120	105
75	145	125	110
80	150	130	115
85	155	135	120
90		140	125
95		145	130
100		150	135
105		155	140
110		160	145
115			150
120			155
125			160
130			
135			
140			
145			

## 529-6124SC or 930-6124SC Accessory Kit

### Extended Spindle Kit for 529, 929, 930, 932, 934, 949, 950, 952, 954

- Step 1. - Establish product function
- Step 2. - Establish spindle type required
- Step 3. - Measure door thickness
- Step 4. - Establish spindle cut length as per the chart. Cut and deburr spindle to required cut length.
- Step 5. - Assemble new length spindle to lockset.

- Use Standard Spindle.
- Cut spindle length in millimetres.
- No Cutting of Spindle required.
- Door Thickness too large for this function.

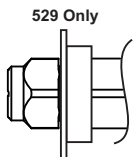
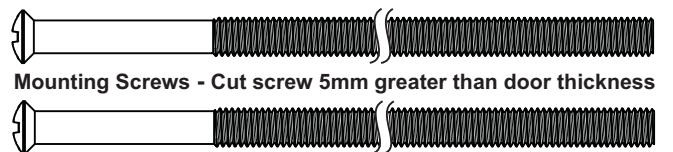

All other functions

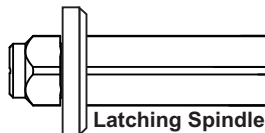

Locking Spindle

