



ASSA ABLOY

Elevation

Keypad User Guide

KEYPAD INSTALLATION AND USER GUIDE



WARNINGS:

Read these instructions prior to the activation of the keypad.
Save this user guide in a safe place for future reference.

TOUCH SCREEN ACTIVATION:

Never use sharp instruments, such as a pencil or pen, to press touchscreen keys.
To prevent damage to the screen, always press the touch screen with your fingertip.

CAUTION:

Changes or modifications to this product not approved by ASSA ABLOY could result in warranty being voided.

IMPORTANT:

Correct installation of the network is paramount to the function of the keypad.
Ensure all details are carried out as per the wiring diagram in the installation instructions.

FINISH CARE:

This keypad is designed to provide the highest standard of product quality and performance.
Care should be taken to ensure a long lasting finish. When cleaning is required use a clean, damp, nonabrasive cloth. The use of lacquer thinners, caustic soaps, abrasive cleaners or polishes for cleaning may result in damage to this product.

NEED HELP:

For assistance with this product please visit: www.lockweb.com.au
Or call on: 1300 LOCK UP (1300 562 587)

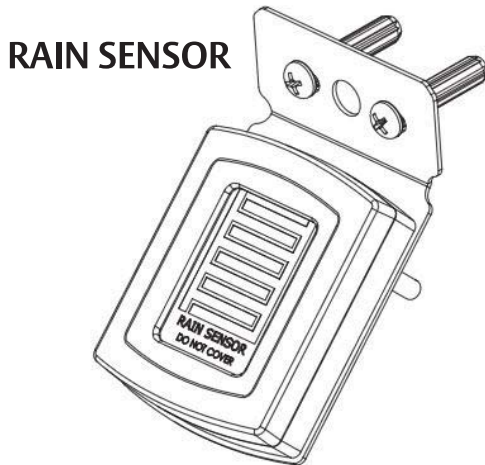

NETWORK ADAPTOR

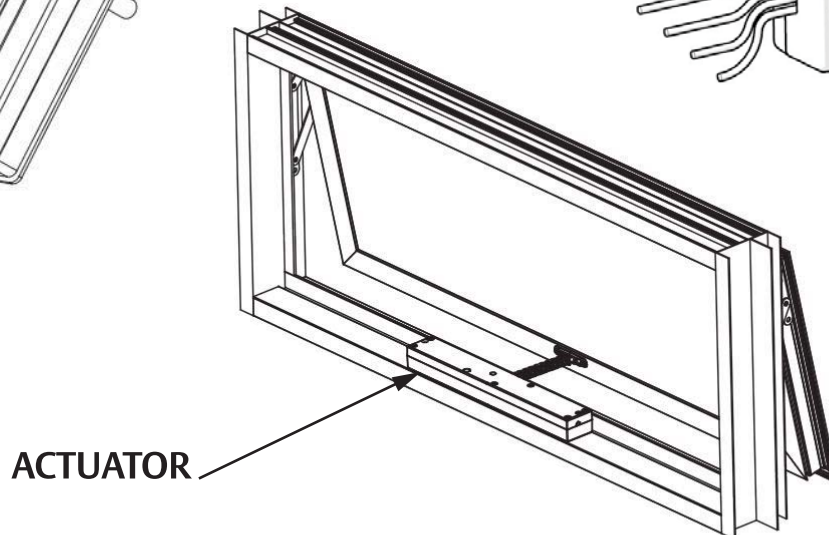
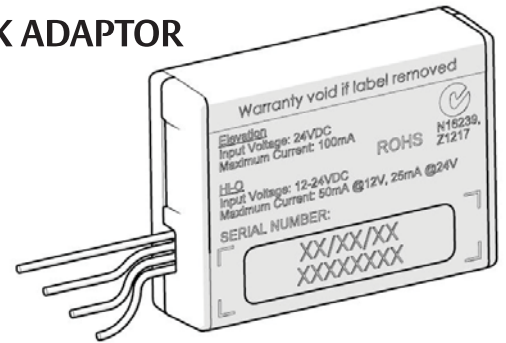

CONTENTS

PAGE

INSTALLER - SETUP AND MODIFICATIONS

1.	Basic Operating Principle- - - - -	- 4
2.	Powering up the System	4
3.	Calibration- - - - -	- 4
4.	System Setup and Configuration- - - - -	- 5-7
	a. Allocating Actuators to Zones	
	b. Checking Zone Allocation	
5.	Modifying System Configuration- - - - -	- 8-10
	a. Removing Actuators from Zones	
	b. Adding Actuators to Zones	
6.	Restoring Previous Settings- - - - -	- 11
7.	Rain Sensor Setup- - - - -	12-17
	a. Adding Rain Sensors to Zones	
	b. Removing Rain Sensors from Zones	
	c. Configuring Rain Sensor Function	
8.	Restarting the Keypad- - - - -	- 18
9.	Trouble Shooting- - - - -	- 18

USER GUIDE

10.	Home Page- - - - -	- 19
11.	Selecting A Window Position- - - - -	- 20
12.	Backlit Home Button - - - - -	- 21
13.	PIN Code Creation - - - - -	- 22
14.	Service Details - - - - -	- 22
15.	System Warnings - - - - -	- 23-25
16.	Rain Sensor/Actuator Location Matrix- - - - -	- 26-27
17.	Frequently asked questions - - - - -	- 28-29
18.	Zone Names - - - - -	- 29
19.	Wiring Diagram - - - - -	- 30
20.	Notes - - - - -	- 31

INSTALLER - SETUP AND MODIFICATION

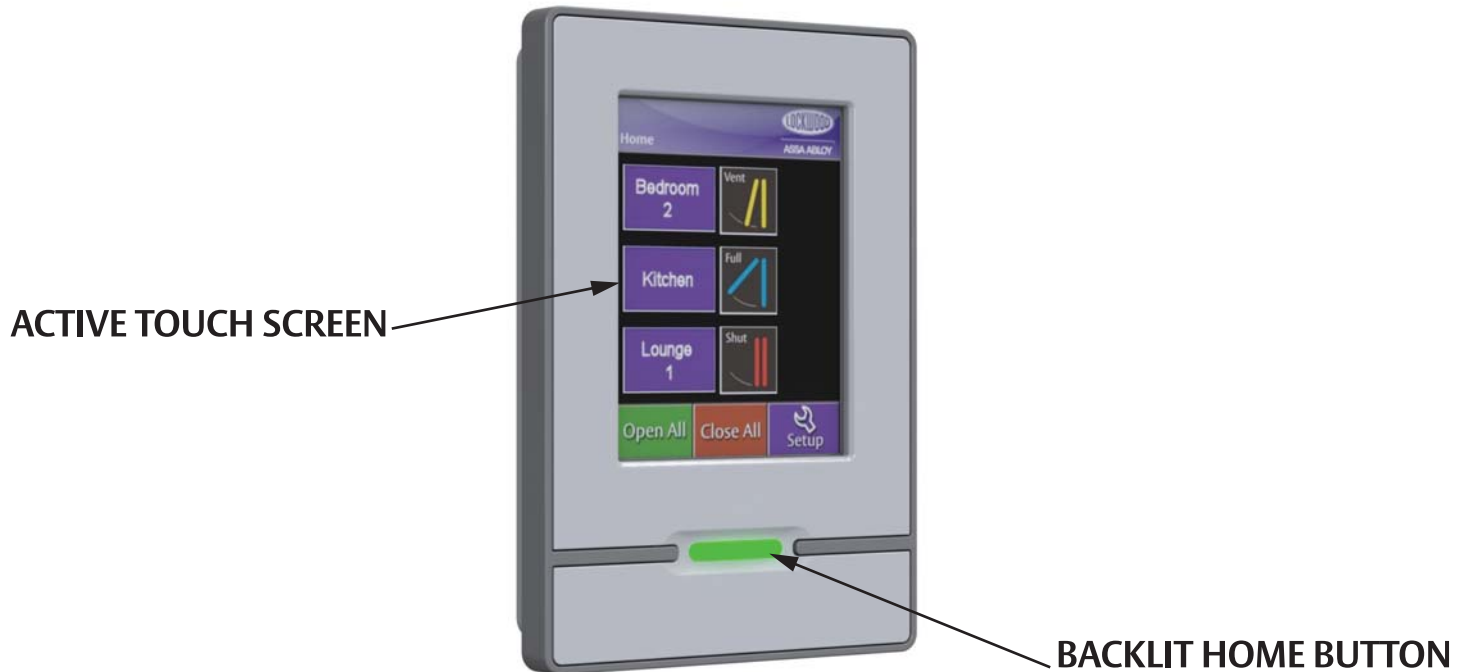

BASIC OPERATING PRINCIPLE

When configuring your network, Actuators are loaded into groups known as Zones. Multiple Zones are available. Each actuator can only be allocated to one Zone.

POWERING UP THE SYSTEM

Ensure all wiring connections are complete before powering up. Ideally the Actuators should be powered up before the Keypads. This ensures the Keypads register all Actuators on the network. If powering up the system isn't possible in this manner, and Actuators have not been recognized, press Restart Keypad in the Setup page. Then proceed to Zone Setup to allocate the Actuators that have not previously registered.

CALIBRATION – Ensure there are no obstructions blocking the windows.

Once all Actuators are registered the system will proceed to a calibration screen. Press Calibrate Actuators. All actuators will move open and close twice. If a warning is displayed stating 'Window Obstructed' this means that an Actuator has performed a safety stop. Locate this window. Press Home and then Close All. Only the obstructed window will close. Fix the obstruction. Then press Calibrate Actuators to continue.

SYSTEM SETUP AND CONFIGURATION

An Actuator can only be assigned to **one** Zone

Allocating Actuators to Zones:

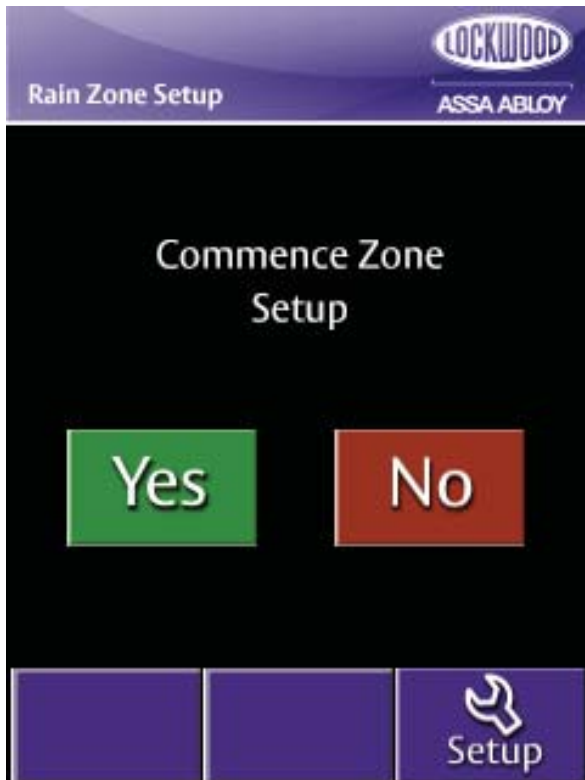

This screen will appear once the auto calibration is complete.

Press **Yes** to commence zone setup.

No will take you to the home page where options of **Open All**, **Close All**, and **Setup** will be available.

Note: There are a total of 30 zone names to choose from.

Zone names cannot be customised.

See page 29 for the list of the names

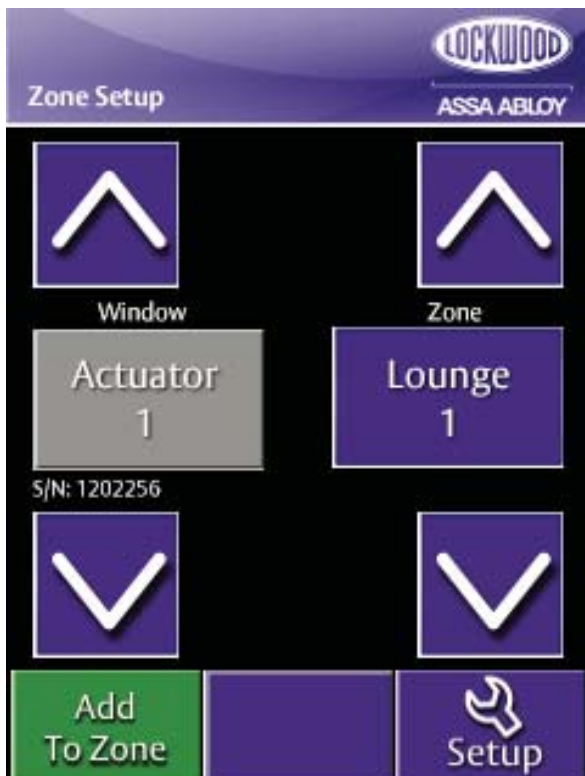

There are two ways to assign Actuators to zones:

1. If serial numbers are known (from page 26):

If not proceed to section 2 below.

Use the **arrow** keys to scroll, matching the serial number on the left with the desired zone on the right.

Press **Add to Zone** and confirm your selection.

2. If serial numbers are not known:

Press each **Actuator** button on the left.

The corresponding Actuator will open.

Note: After 5 minutes it will close automatically.

Visually locate this Actuator. Then use the **arrow** keys on the right to select the desired zone.

Press **Add to Zone** and confirm your selection.

The window will now close if open.

*Note: Pressing the **Actuator** button again will also close the window.*

Repeat either process until all Actuators are allocated to your desired zones.

Press **Exit & Save** then **Yes** to save your zone settings.

SYSTEM SETUP AND CONFIGURATION

Checking Zone Allocation:

Method 1.

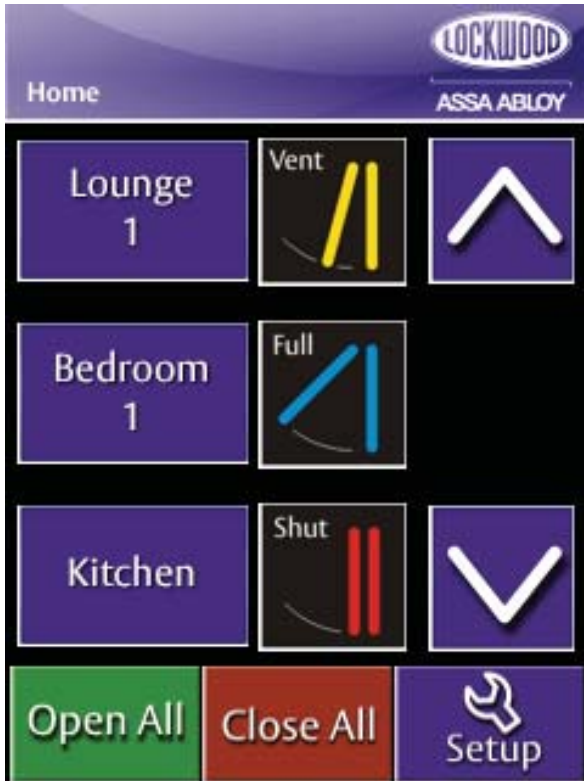

1. Use the **arrow** buttons to scroll through the zone list.

2. Press the zone name, e.g. **Lounge 1**

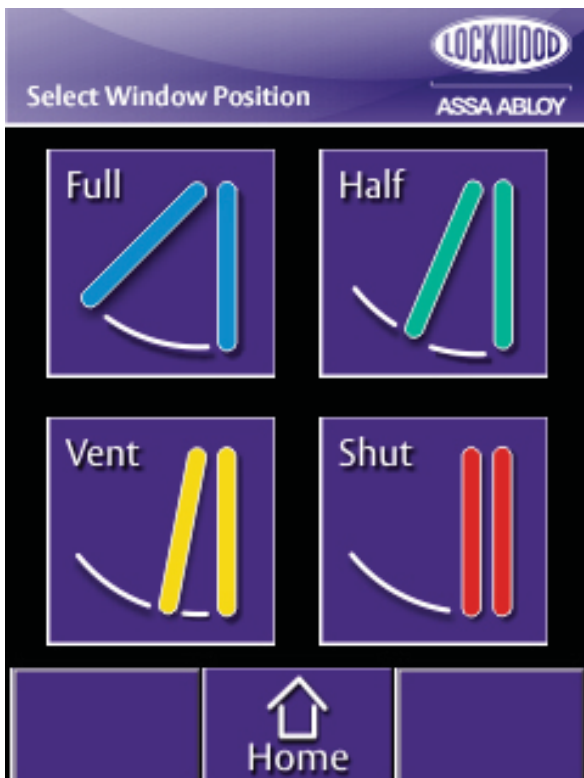

3. Press any opening position and observe which windows move to check that the Actuators are assigned to the correct zones.

Repeat steps 1, 2, and 3 until all zones have been checked.

SYSTEM SETUP AND CONFIGURATION

Checking Zone Allocation:

Method 2.



You can view zones to see which Actuators have been assigned to a particular zone.

1. Press **View Zones**.



2. Use the appropriate **arrow** buttons to scroll through either the Actuator list or the Zone list.

Note: No changes can be made in this screen.

MODIFYING SYSTEM CONFIGURATION

Removing Actuators from zones:

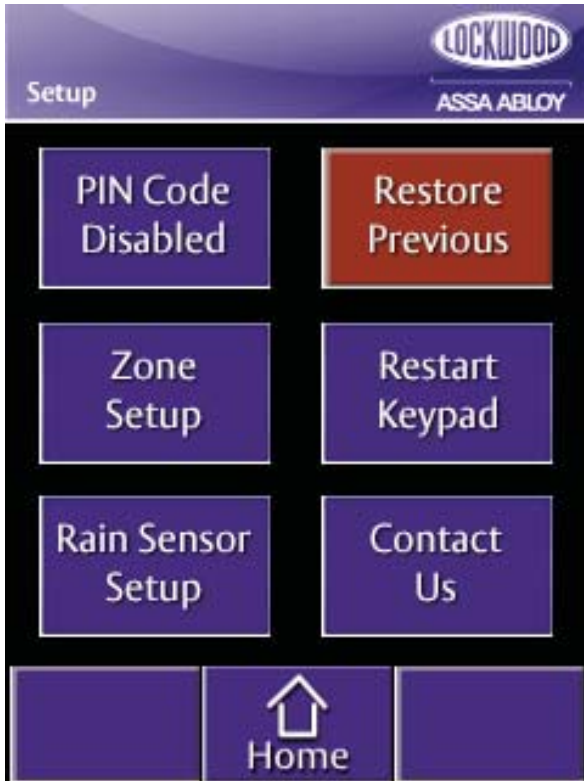

Note: All Rain Sensors must be removed from a zone before removing Actuators from that zone.

1. From the home page, press **Setup**.
2. Press **Zone Setup**.
3. Press **Remove from Zone**.

This now takes you to a screen where you can remove Actuators from zones.

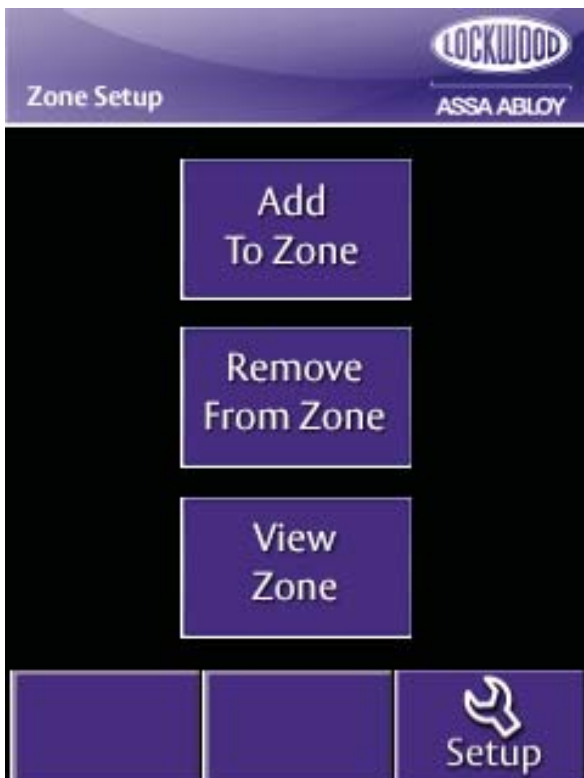

4. Using the **arrow** keys on the right, scroll to the zone from which you want to remove an Actuator.
5. Press the **Actuator** button on the left. The corresponding Actuator will open. Locate this Actuator and check that it is the one you wish to remove.
6. If it is, press **Remove From Zone** and confirm your selection (the Actuator will close automatically when confirmed).
7. If it is not, press the **Actuator** button again to close this Actuator.

MODIFYING SYSTEM CONFIGURATION

Removing Actuators from zones:



8. Then use the **arrow** keys to scroll to the next actuator in the zone and repeat the process until the desired Actuator is found.

Note: Actuator locations may have also been previously noted on pages 26 & 27

9. Press **Setup** to exit.

You will not be prompted to save at this point.

The reason for this is explained in the Restore Previous section (page 11). However you can save if you wish by exiting the Zone Setup page.

Adding Actuators to zones: *Mainly used for modifications to zone setups.*



1. Press **Zone Setup**.

MODIFYING SYSTEM CONFIGURATION

Adding Actuators to zones:

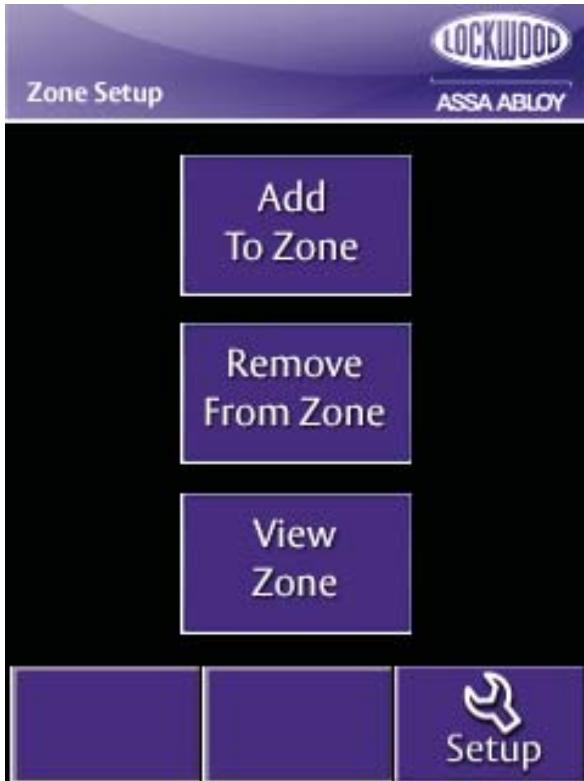

2. Press **Add To Zone**.

This now takes you a screen where you can add **Actuators** to zones.

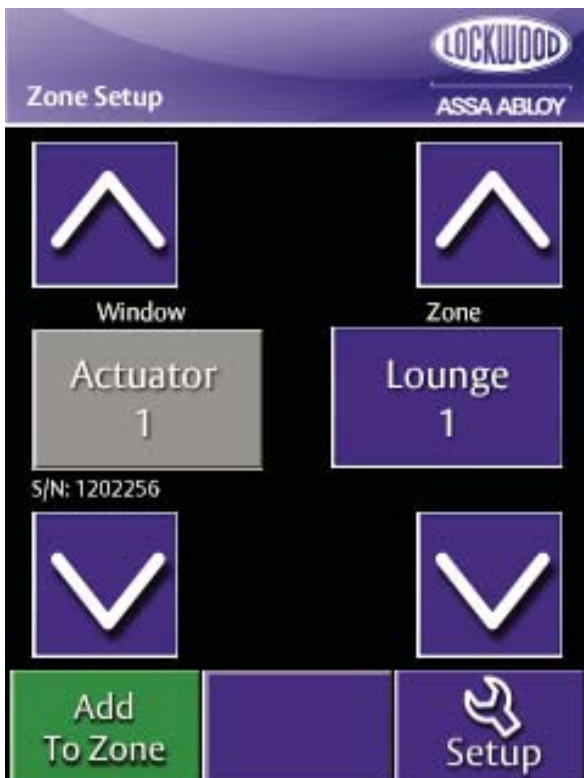

3. Press the **Actuator** button on the left.
The corresponding actuator will open.

4. Locate this Actuator then use the **arrow** keys on the right to select the desired zone.
Once matched press **Add to Zone** and confirm your selection.

Important: Repeat the process ensuring **all** Actuators are allocated to your desired zones **before** exiting and saving.

5. Press **Exit & Save**, and then **Yes** to save your modified zone settings.

Note: Serial Number location method can be used if required, see page 5.

RESTORE PREVIOUS SETTINGS



Restore Previous will enable you to restore the previously saved zone settings.

Not recommended for use if Rain Sensors are installed. Rain Sensor settings will be deleted and will need to be reprogrammed if Restore Previous is used.

1. Press **Setup** on the home screen to display this screen.
2. Press **Restore Previous**.

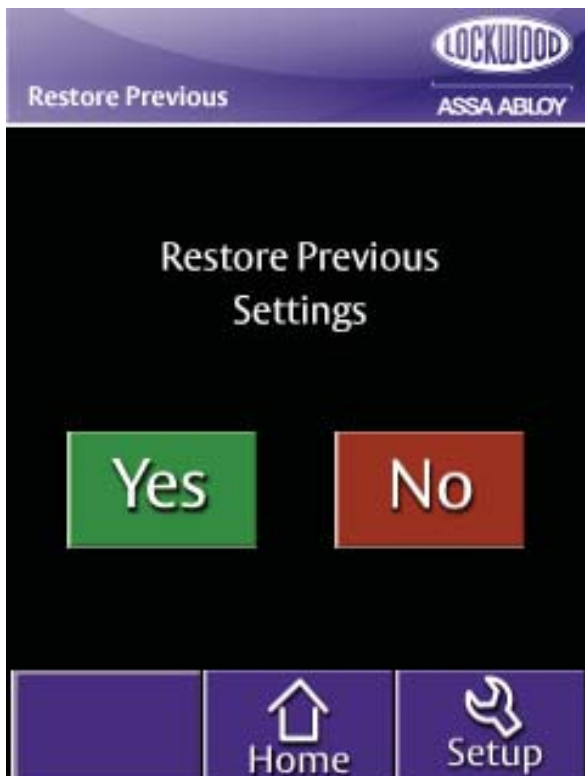

You will be prompted **Yes** or **No**.

1. Press **Yes** to restore the previously saved zone settings.

Explanation continued from page 9:

Restore Previous will only restore the previously saved settings, not necessarily your original saved settings.

RAIN SENSOR SETUP

Adding Rain Sensors to Zones:

Note: A maximum of 4 Rain Sensors can be connected to a Network.

1. Press **Setup** on the home screen to view this screen.

2. Press **Rain Sensor Setup**.

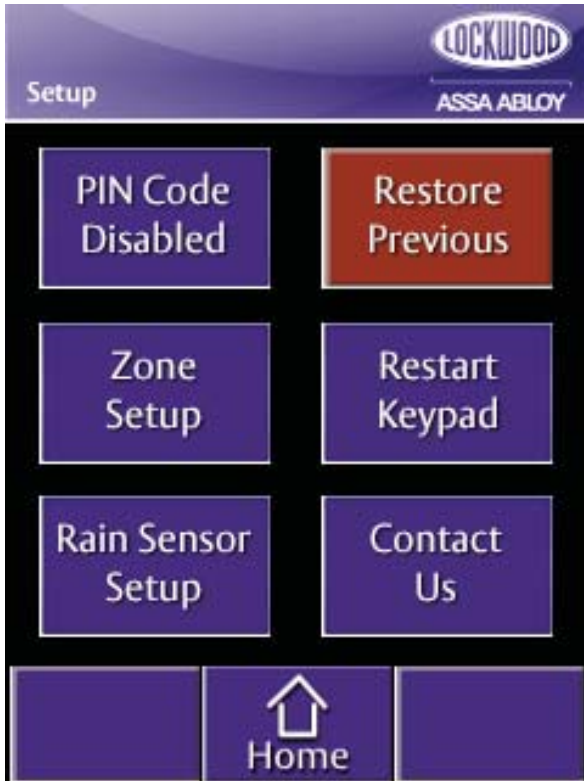

3. Press **Add RS To Zone**.

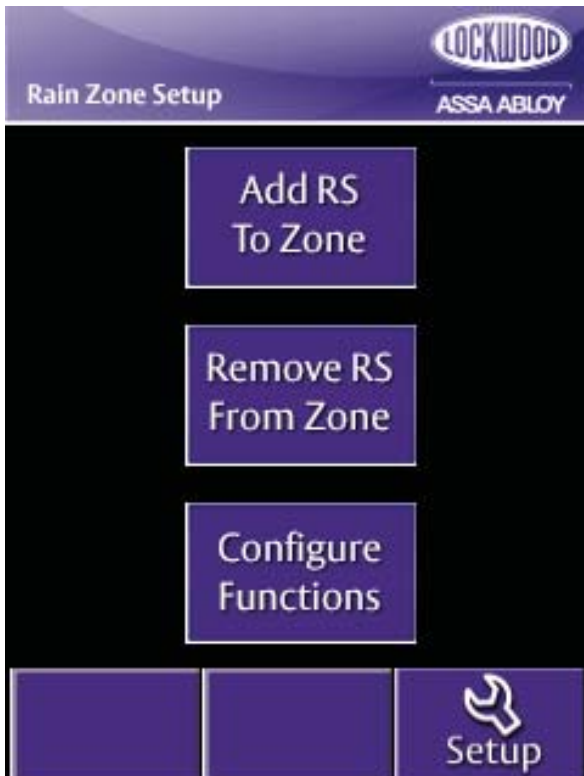

RAIN SENSOR SETUP

Adding Rain Sensors to Zones:

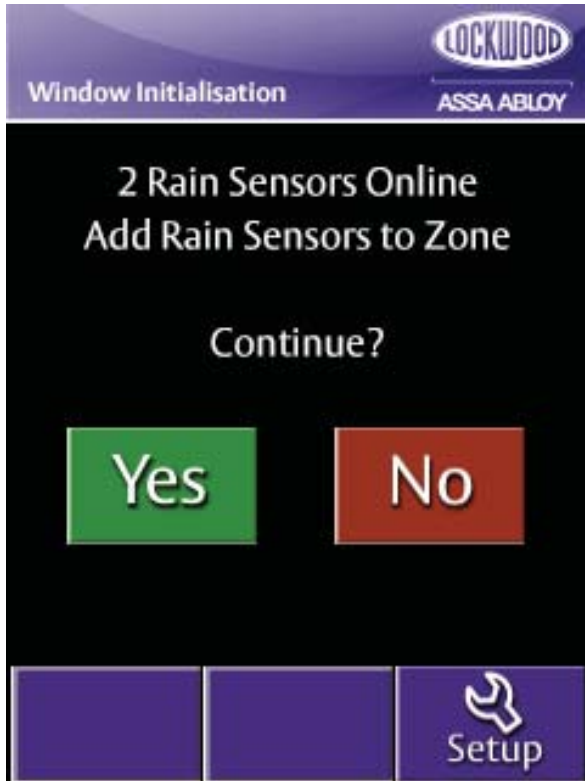

Confirm that the message displays the correct number of rain sensors online.

4. Press **Yes** to confirm and proceed to the next screen.
Press **No** or **Setup** to go back to the setup screen.

Note: The system may take a few minutes to register the Rain Sensors. Go back to the setup page and then back into the Rain Sensor Setup page if the incorrect number of Rain Sensors has been displayed.

IMPORTANT:

- Rain Sensors are assigned to zones, and before Rain Sensors can be added, zones must be setup.
- Rain Sensors can be added to multiple zones.
- The serial number on a Network Adaptor and the dwelling position of the Rain Sensor it interfaces with must be noted during installation to know which zone(s) each Rain Sensor is to be assigned to. Refer to page 26.



5. Use the **arrow** keys to match the Rain Sensor to the appropriate zone.

6. Press **Add to Zone**.

RAIN SENSOR SETUP

Adding Rain Sensors to Zones:



6. Confirm your selection by pressing **Yes**.

A confirmation screen will be displayed and the system will return to the Add RS To Zone page.

The Rain Sensor will no longer be displayed on the left hand side of the screen once assigned to a zone.

If more than one zone is desired for a particular Rain Sensor, scroll to that zone and repeat the process above.

The Rain Sensor will reappear once a new zone is displayed.



7. Press **Exit & Save** then **Yes** to confirm your selection.

Note: If all Rain Sensors have been added to all zones the Add to Zone page will appear blank.

RAIN SENSOR SETUP

Removing Rain Sensors from Zones:

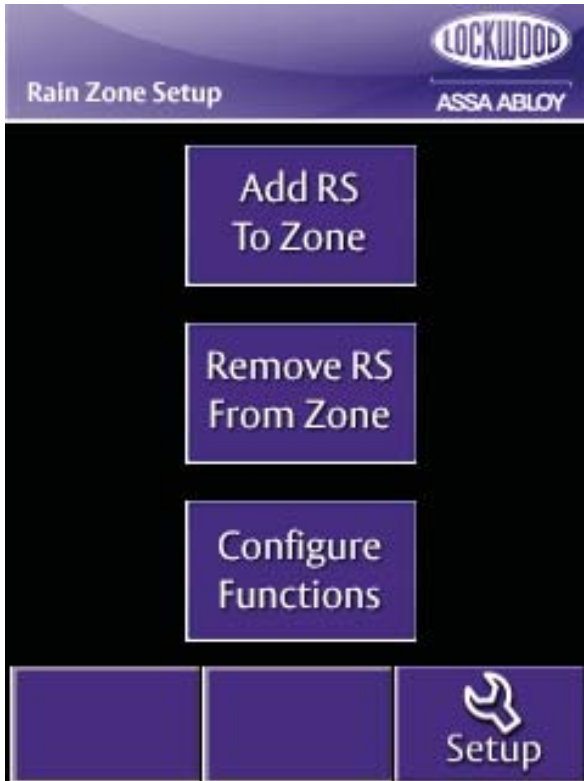

1. Press **Remove RS From Zone**.



Confirm that the message displays the correct number of rain sensors online.

2. Press **Yes** to proceed to the next screen.

RAIN SENSOR SETUP

Removing Rain Sensors from Zones:



3. Use the **arrow** keys to scroll to the desired zone and match it with the desired Rain Sensor.
4. Press **Remove from Zone**.
5. Confirm your selection by pressing **Yes**.
A confirmation screen will be displayed and then the system will return to the Remove From Zone page.

Note: The Rain Sensor will no longer be displayed on the left hand side once removed from the Zone.

6. Press **Exit & Save** once all desired Rain Sensors have been removed.

Note: Restore Previous will not restore Rain Sensor settings. These will be deleted. See page 11.

Configuring Rain Sensor Function:

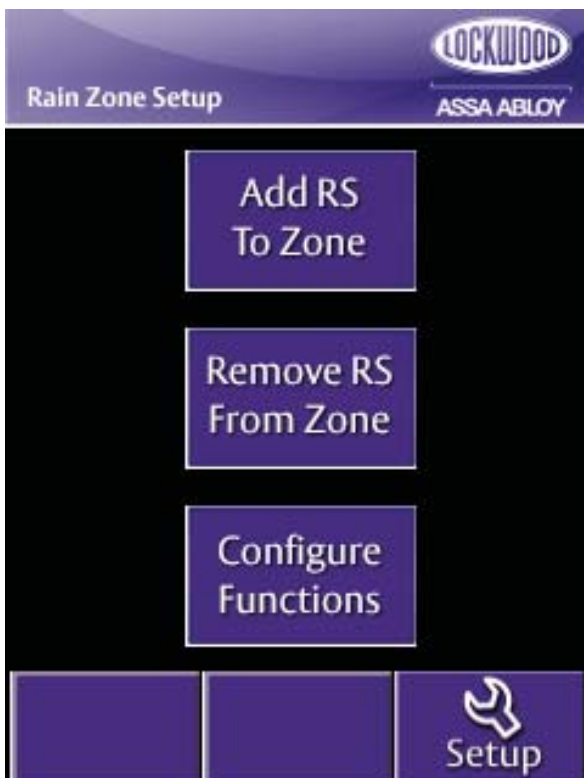

There are options in the Rain Sensor Setup page that allow you to set the way the **ZONES** react in the event of rain.

These options are :

- Disable or Enable **Reopen**: in the event of rain, the Actuators will close. If Enable Reopen is selected the Actuators will automatically reopen to their previous positions once the Rain Sensor has dried.
- Shut or Vent: in the event of rain the Actuators will move to this position.

The above options are customized as follows:

1. Press **Configure Functions**.

RAIN SENSOR SETUP

Configuring Rain Sensor Function:



2. Use the **arrow** Keys to scroll to the desired zone.

3. Select the functional options by pressing the buttons. (toggle)
The options displayed are the current settings.

Default settings are: Disable Reopen, and Shut.
The other options are shown in the picture.

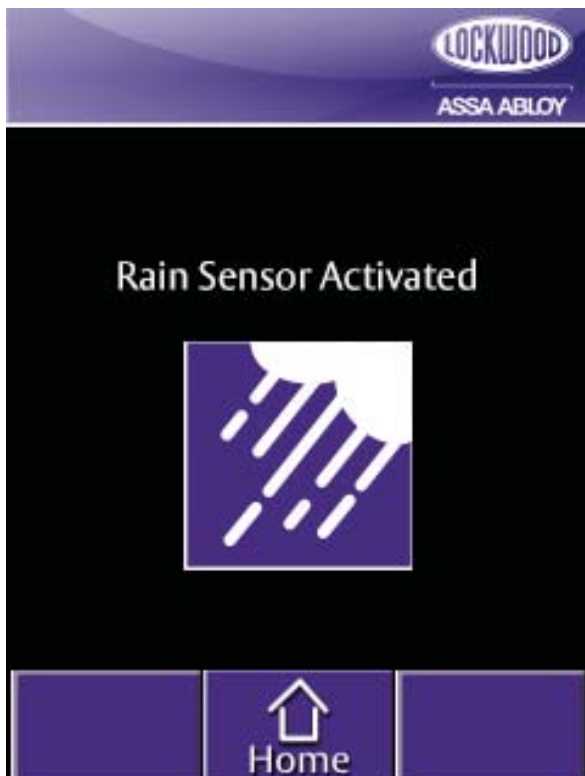

Basic Rain Sensor Function

Once the Rain Sensor detects rain, it will immediately activate the windows to start closing to the chosen configuration, i.e. shut or vent, and displays the icon shown here.

The windows will reopen 15 minutes after the Rain Sensor has dried.
Note: The sensor can be placed in open areas if desired and does not need to be next to the assigned zone/window.

The Rain Sensor will not be activated by dew.

RESTARTING THE KEYPAD



This function is used when a zone warning is displayed on the Keypad indicating that one or more of the Actuators have not been recognized by the Keypad.

1. Wait for at least 2 minutes.
If the warning is still present push Restart Keypad in the Setup page.

The Keypad should now recognize the Actuator.
If it does not, then follow the steps in the next section.

TROUBLE SHOOTING



Operate the zone on the Home page displaying an explanation mark.

The window that does not move corresponds to the Actuator that has not been recognized. Check for loose wiring to that Actuator.

If no loose wires are found then the Actuator could be at fault.

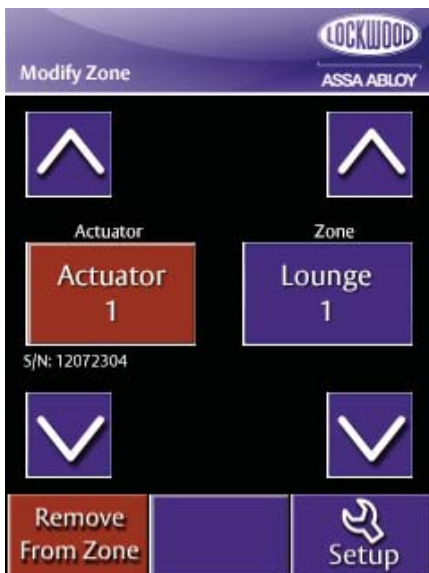

To remove this Actuator from the zone so the warning is no longer displayed, carry out the following steps:

Note: If a Rain Sensor is assigned to this zone it will need to be removed before the Actuator can be removed.

1. Press **Setup, Zone Setup**.
2. Press **Remove From Zone**.
3. Press the right hand side **arrow** keys to scroll to the zone that is displaying an explanation mark on the home page.
4. If necessary, press the left hand side **arrow** keys and scroll to the Actuator that is **coloured red**.
5. Press **Remove From Zone**.
6. Press **Setup** to go back to the Zone Setup page, then press **Setup** again to go back to the Setup page.
7. Press **Yes** to save your settings.

The warning should now be resolved in the Home page.
If not, contact your installer.

USER GUIDE - HOME PAGE

ZONE STATUS

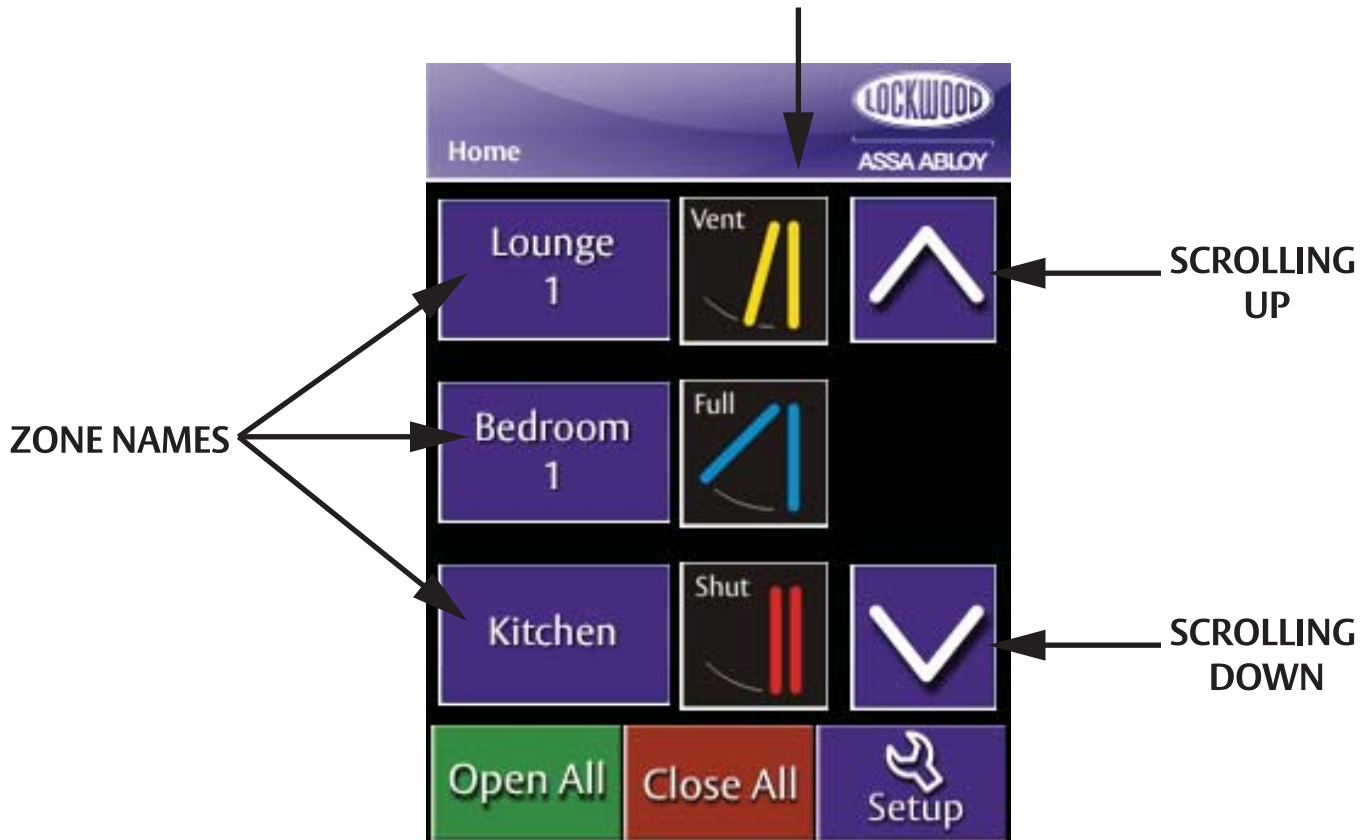

LABEL	DEFINITION
Zone Names	A maximum of 3 Zones are shown on the Home page at any one time. Press the Zone name to display the 4 preset window position options. Refer next page.
Zone Status	This shows the current opening position of the corresponding windows in that Zone.
Scrolling up / down	Press these buttons to scroll through the entire Zone list. Displayed if more than 3 zones are set up.
Setup	Pressing this button takes the user to another screen to allow several setup options.
Open all	Pressing this button will open all Actuators on the network.
Close all	Pressing this button will close all Actuators on the network.

SELECTING A WINDOW POSITION

After pressing any of the pre-set positions below, the Actuators will automatically move to that position. Press **Stop** at any time to stop the Actuators. A symbol will be displayed next to the zone highlighting the fact that the window is not at a pre-set position.

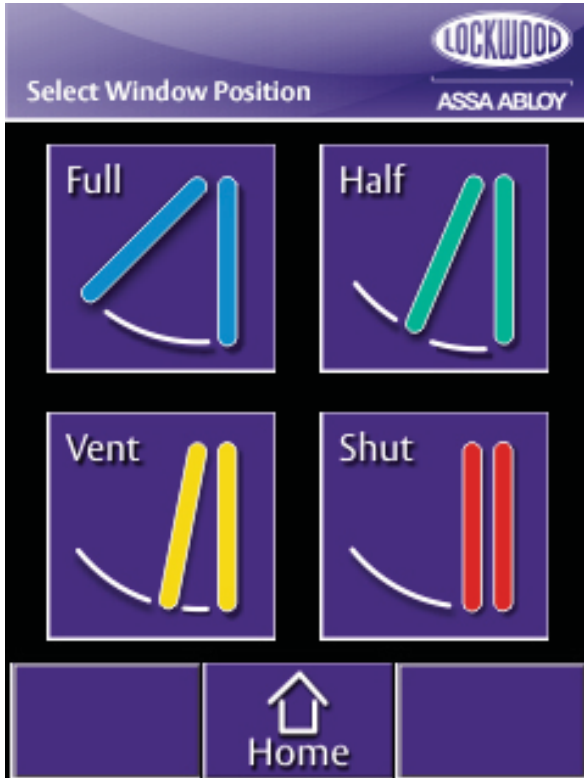

Full:
Press this button to fully open the windows in that Zone.

Vent:
Press this button to vent the windows in that Zone.
This position will open the window 15mm

Half:
Press this button to open the windows in that Zone half way.

Shut:
Press this button to shut the windows in that Zone.

Note: Maximum default chain length is 300mm. Your window might be limited to a shorter length due to restrictions. Contact your window manufacturer if the chain length needs to be adjusted.

BACKLIT HOME BUTTON



BACKLIT HOME BUTTON

Pressing and releasing the **Backlit Home Button** will return you to the Home page.

If no buttons are pressed for 120 seconds the screen will go into sleep mode.

Touching the screen or pressing the **Backlit Home Button** will reactivate the screen.

Pushing and holding the **Backlit Home Button** for 5 seconds before releasing will close all windows on the network. An audible sound will be heard upon pushing the **Backlit Home Button** and another at the 5 second mark.

Pushing and holding the **Backlit Home Button** for **10 seconds** before releasing will allow the user to deactivate the screen so that it can be cleaned. An audible sound will be heard at the 10 second mark.

Upon release, the screen can be cleaned without activating it. After 180 seconds the screen will revert to sleep mode. You can unlock the screen at any time during the 180 seconds by pushing the **Backlit Home Button**.

BUTTON COLOUR INDICATION:

Flashing Green: the **Backlit Home Button** will flash green when the **Actuators** are operating in any direction.

Flashing Red: the **Backlit Home Button** will flash red if there is a communication fault in the network or the window has been obstructed.

PIN CODE CREATION

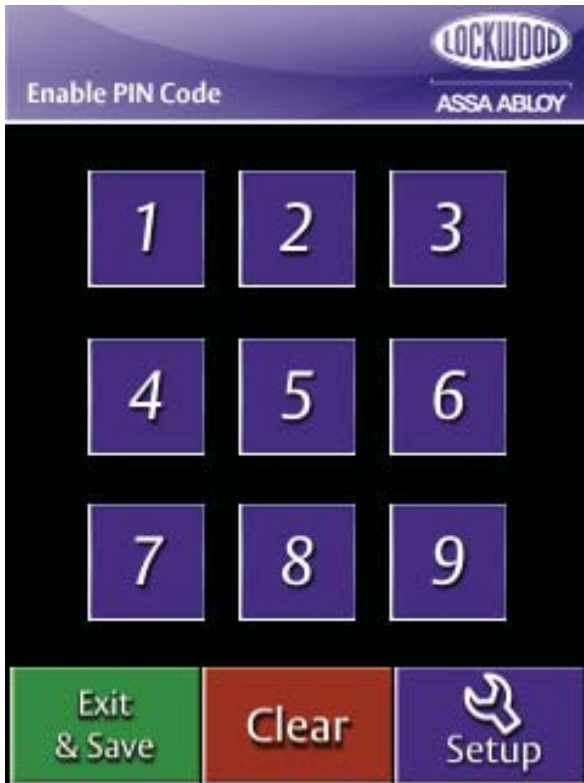

Write your desired PIN code here:

--	--	--	--

ENABLE PIN CODE:

1. Press **Setup** from the Home page
2. Press **PIN Code Disabled**.
3. Press **Yes** to continue.

ENTERING A 4 DIGIT CODE:

1. Enter your 4 digit code.
A star symbol (*) will appear on the top bar for each digit you touch.
 2. Press **Save** when you have entered the 4 digits.
Note: Only the first 4 digits you enter will be saved.
- Your PIN Code is now active.

DISABLE PIN CODE:

From the Setup Page, press **PIN Code Disable**.
You will be prompted 'Do you want to disable the PIN Code?'
Press **Yes** to confirm this action.

Note: The default override PIN code is 4811. Also pin codes are Keypad specific. The pin code will need to be entered into both Keypads.

SERVICE DETAILS



Service Contact details can be displayed on the screen.

1. Press **Setup, Service Details**.

If the screen is damaged, remove the Keypad from the Wall Bracket to view contact details.

SYSTEM WARNINGS:



WINDOW OPERATING:

This symbol will appear when a window has been activated and is completing its task. You can push **Home** or the **Backlit Home Button** to continue using the Keypad while the window is operating.



WINDOW OBSTRUCTED:

Check all windows for obstructions.
This could be during either the opening or closing sequence of the windows.

If a window has been obstructed it must be run in the opposite direction and the obstruction removed before the window can continue in the original direction again.

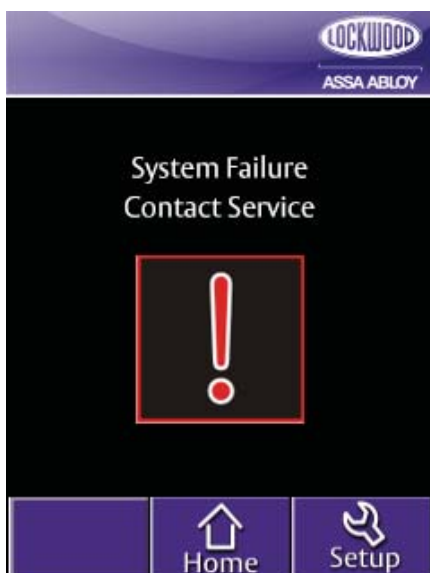

SYSTEM FAILURE:

This maybe a network communication fault.

If possible press **Restart Keypad** from the setup page.
If the problem persists press **Setup**, then press **Service Details**.
Call the appropriate number to speak to a customer service representative.

SYSTEM WARNINGS:



RAIN SENSOR/NETWORK ADAPTOR LOST COMMUNICATION:

Check all direct wiring to the Network Adaptor.

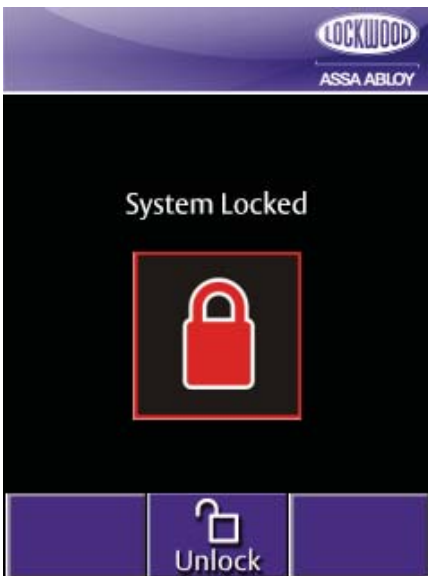

SYSTEM LOCKED BY PIN CODE.

Press **Unlock** located at the bottom of the screen to enter your PIN Code.

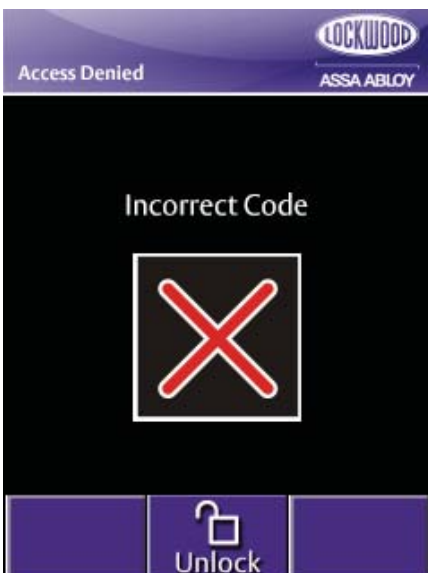

INCORRECT PIN CODE HAS BEEN ENTERED:

If you have forgotten your PIN Code, type in: 4811

This is a default override code that will allow you to gain access to the Keypad.

You should reset your PIN Code once you access the Keypad.

SYSTEM WARNINGS:

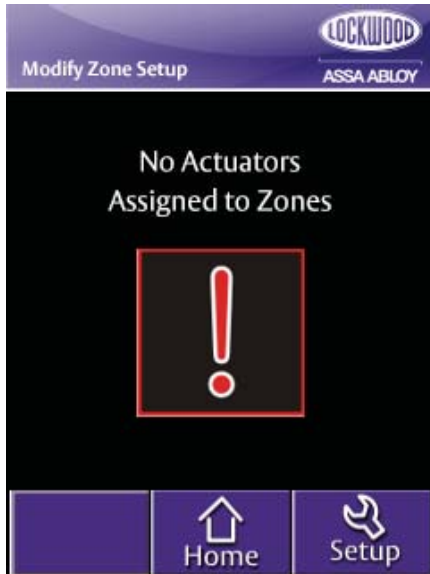

This screen will appear if you try to remove Actuators from zones if there aren't any zones setup.



This screen will appear if trying to add Rain Sensors to zones but there are no new zones available, and every Rain Sensor has been added to every zone.

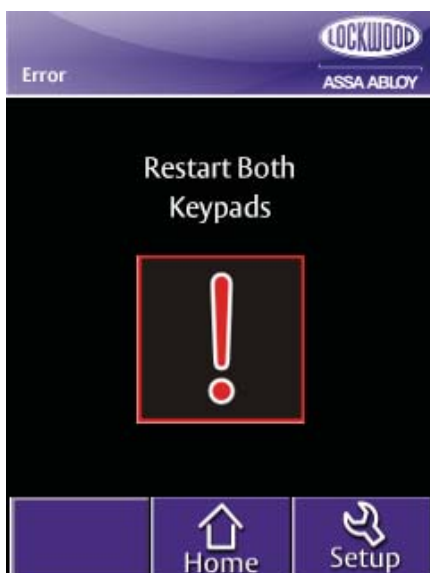

It is possible for this error to occur mainly on large networks with over 20 Actuators during power up.

Restarting both Keypads will allow them to see the Actuators as they will not lose power during this process.

Press **Setup, Restart Keypad.**



RAIN SENSOR/ACTUATOR LOCATION MATRIX

Place the spare serial number label, or write the serial number in one column, and the location and/or zone name in the next. See example below.

Note: Only the bottom line of the label refers to the serial number.

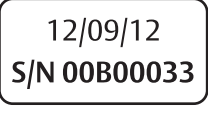
NETWORK ADAPTOR SERIAL NUMBER:	LOCATION ON BUILDING/ZONE:	NETWORK ADAPTOR SERIAL NUMBER:	LOCATION ON BUILDING/ZONE:
e.g. 	Northeast corner/ Lounge 1, Kitchen		

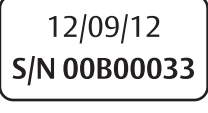
ACTUATOR SERIAL NUMBER:	ZONE/LOCATION:	ACTUATOR SERIAL NUMBER:	ZONE/LOCATION:
e.g. 	Northeast corner/ Lounge 1, Kitchen		



KEYPAD – ACTUATOR/RAIN SENSOR MANAGEMENT MATRIX CONT.

ACTUATOR SERIAL NUMBER:	ZONE/LOCATION:	ACTUATOR SERIAL NUMBER:	ZONE/LOCATION:

FREQUENTLY ASKED QUESTIONS

<p>Can I close my windows if the Keypad is not responding?</p>	<p>Possibly. Hold the Backlit Home Button for 5 seconds and release when the second beep is heard. The first beep will be heard when you first push the button. If this does not close the windows, call the installer.</p>
<p>How many Keypads can I use on a network?</p>	<p>A maximum of two Keypads can be installed on one network.</p>
<p>There is a red flashing light on the bottom of the Keypad. What does this mean?</p>	<p>This indicates that there is something wrong. Press the touch screen to see what error message is displayed. It could be one of the follow scenarios:</p> <ol style="list-style-type: none"> 1. Window Obstructed. Remove any obstacles and check that the window pivots freely. 2. Check that the maximum 9kg pushing force of the Actuator has not been reached. Most likely the windows will be close to fully open. 3. A communication fault in the network. Press the Restart Keypad button in the Setup page if possible. If this does not fix the fault, check all wiring connections. If this page cannot be accessed call the installer.
<p>I have replaced an Actuator on the network. What do I do next?</p>	<p>The power should be off to the entire system. Repower the system and then calibrate it as displayed on the Keypad. If Actuators do not register press the Restart Keypad button in the Setup page.</p>
<p>When I touch the Full position button some of my windows don't fully open. Why is this?</p>	<ol style="list-style-type: none"> 1. The chain length may be restricted Refer Actuator installation instructions. 2. The window may be obstructed. Clear any obstructions and ensure the window pivots freely. The Backlit Home button will flash red. 3. The Actuator may have reached its maximum pushing capacity of 9kg. Contact installer.
<p>Power failure.</p>	<p>If only the Keypad is powered off and on, the system will not need to calibrate. Once a system has been programmed, if it is powered off and on it will always go to the auto calibration page.</p>
<p>The Rain Sensor Activated icon is on the screen, but I want to open my windows. Can I do this?</p>	<p>Yes. You can manually override the position of the Actuators even when the Rain Sensor has been activated. Touching the screen will clear the Rain Sensor icon. You can then operate the windows as normal. <i>Note: The Rain Sensor Activated icon will continue to appear until it has been dry for 15 minutes and the Keypad touch screen has been activated.</i></p>
<p>Why is it necessary to calibrate the Actuators?</p>	<p>This is so the Keypad knows the home position and the maximum open position for each Actuator.</p>
<p>I've forgotten my PIN Code. What can I do?</p>	<p>You can enter the Keypad by using the code: 4811 It is highly recommended that you reset your PIN Code once you have entered the Keypad.</p>

FREQUENTLY ASKED QUESTIONS CONTINUED

How do I reset my PIN Code?	From the PIN Code page, disable the current PIN Code. Then you can simply re-enter a new PIN Code.
-----------------------------	--

ZONE NAMES

Lounge 1	Upstairs	Zone 2
Lounge 2	Downstairs	Zone 3
Bedroom 1	Hall	Zone 4
Bedroom 2	North Facing	Zone 5
Bedroom 3	South Facing	Zone 6
Bedroom 4	East Facing	Window 1
Study	West Facing	Window 2
Bathroom 1	Factory	Window 3
Bathroom 2	Store Room	Window 4
Kitchen	Zone 1	Window 5

WIRING DIAGRAM

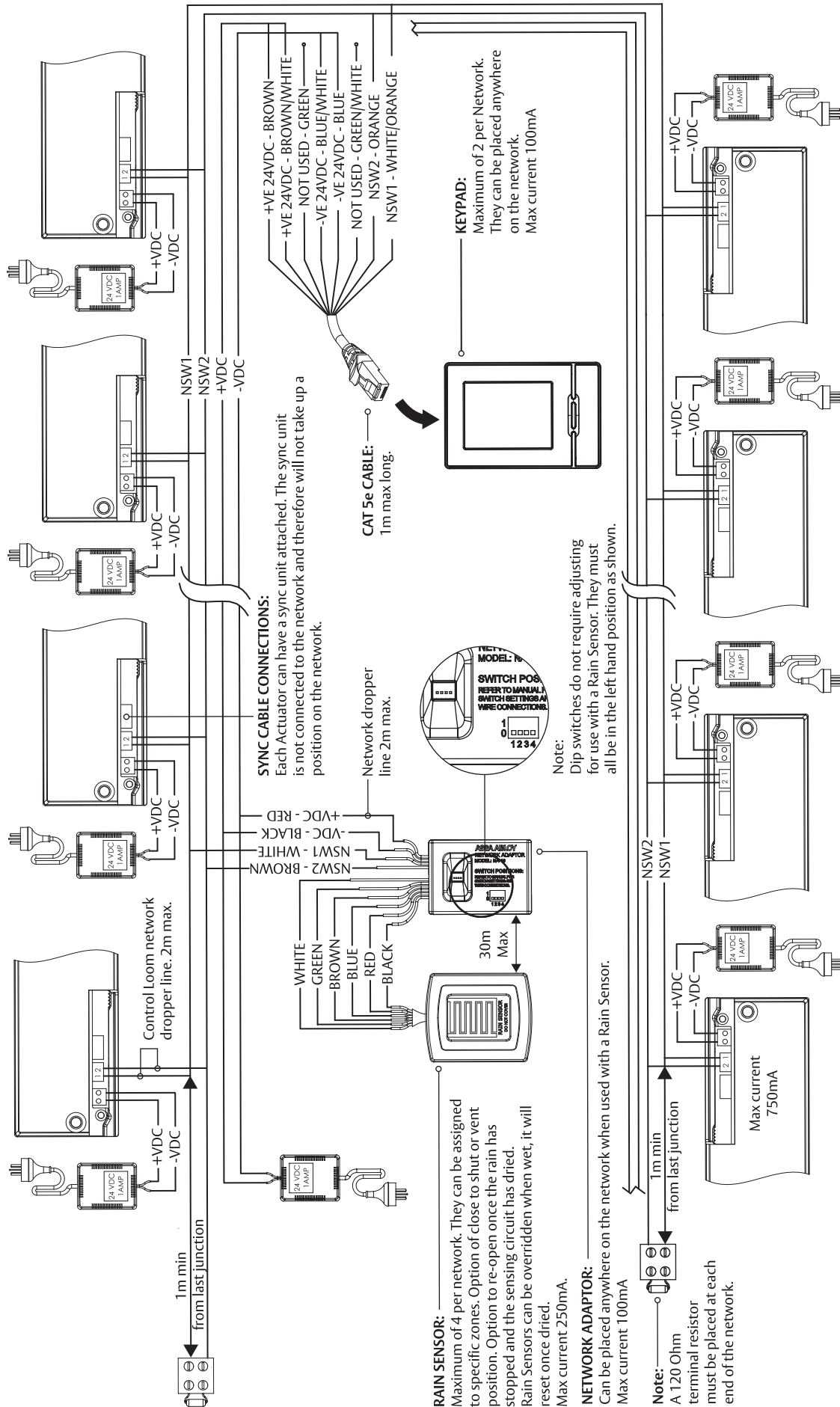



NOTES

A series of horizontal dashed lines for taking notes.

ASSA ABLOY is the global leader in door opening solutions, dedicated to satisfying end-user needs for security, safety and convenience



Lockwood is the leading brand in the Australian locking industry. With an established reputation for high quality products, this iconic brand provides a wide range of locking solutions to residential housing, commercial building and industrial application markets. Lockwood is supported by an extensive distribution and after-sales support network. Our customers include retailers, architects, trade and industrial personnel, locksmiths and security dealers.

ASSA ABLOY

ASSA ABLOY is the global leader in door opening solutions, dedicated to satisfying end-user needs for security, safety and convenience.

ASSA ABLOY is represented in all major regions, in both mature and emerging markets, with leading positions in Australia, Europe and North America.

As the world's leading lock group, ASSA ABLOY offers a more complete product range of door opening solutions than any other company in the market.

Australia
1300 LOCK UP (1300 562 587)
lockweb.com.au

ASSA ABLOY Australia Pty Ltd
235 Huntingdale Road
Oakleigh, Victoria, 3166
Australia

info.au@assaabloy.com
assaabloy.com.au

